

BUCKINGHAM MFG.

INSTRUCTIONS / WARNINGS - 486 SERIES – BuckSqueeze-Lite™

Warning: Do not use this product if you cannot understand and follow the instructions and warnings that come with it and complete all necessary functions.

DESCRIPTION:

Model 486 Series – Wood Pole Fall Restriction Device (WPFRD) for Distribution Poles (Typical BuckSqueeze-Lite™ shown (Buckingham PN 486DK4MA) other models may have varying lengths, options & hardware from figures shown.

The BuckSqueeze-Lite™ is Buckingham's Wood Pole Fall Restriction Device featuring enhanced work positioning capabilities. With cutouts being a leading cause of injuries to line technicians, Buckingham Mfg. Co., with the input of actual line technicians, has developed the Model 486 series wood pole fall restriction devices that squeeze the pole in the event of a cutout or fall while in the elevated position. The BuckSqueeze-Lite™ cinches tightly around the pole, using the user's weight, to minimize fall distance in the event of a cutout or slip while ascending or descending a pole. Fall distance may vary based upon adjustment, pole condition and the environment in which this product is being used. When adjusted and used in accordance to the Instructions outlined below, fall distance will not exceed that permitted for the Type 'AB' unit and defined by the ASTM F887 and CSA Z259.14 standards (round poles only). Examples of reasons why falls from poles, which result in serious injury or fatality, occur are: user error, climbing around obstructions, fatigue, electrocution, wood rot, previous gaff holes, a crack in the pole or a gaff hitting a foreign object like a nail or screw. The BuckSqueeze-Lite™, if used properly will greatly reduce fall distance that can occur from these hazards.

COMPONENT DESCRIPTION: (Model 486 shown in Fig. 1)

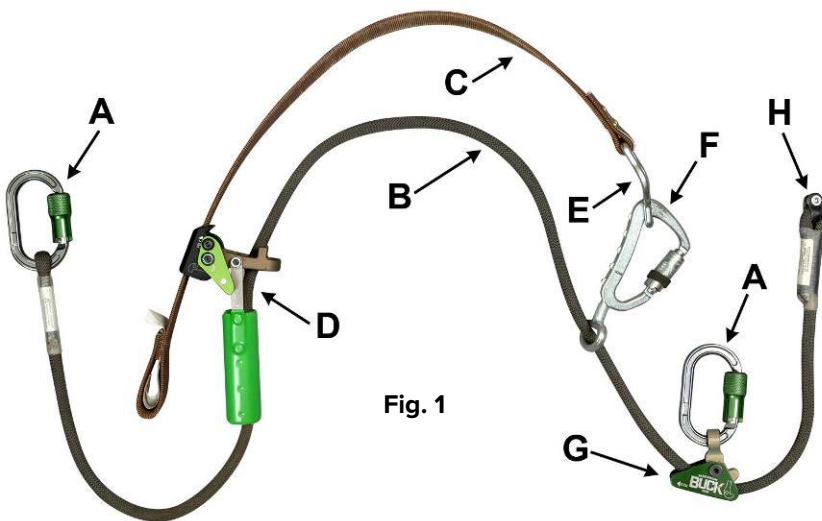

- A - Locking Carabiners x 2 (Fig. 1)
- B - Inner Rope (Black Tough Rope™ Shown – Fig. 1)
- C - Outer Strap (Brown Neoprene Impregnated Nylon – Fig. 1)
- D – Web Grab / Handle Assembly (Fig. 1 & 2)
- E – Nose D-ring (Fig. 1 & 3)
- F - Serrated Rotosnap (Fig. 1 & 4)
Serrated Rotosnap Spring Retention Slot (Fig. 5)
- G – BuckGrab /LAD (Rope – Fig. 1 & 6)
- H - Tail Keeper (Fig. 1 & 7)

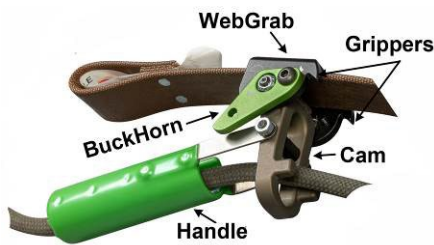

WebGrab / Handle Assembly- Fig. 2



Serrated Rotosnap - Fig. 4



BuckGrab – Fig. 6



Nose D-Ring (shown with Serrated Rotosnap & Metal Strap End Clip) Fig. 3

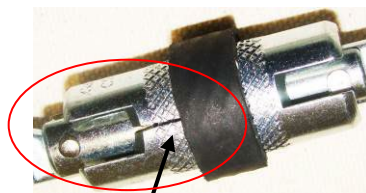

Serrated Rotosnap Gate with Spring Retention Slot Fig. 5



Tail Keeper (connect to M4 Magnet Pouch or 2402G Handline Hook – Fig. 7)

PRIOR TO USE:

- ◆ This equipment is intended for use by properly trained professionals only.
- ◆ Know the job and the regulations governing performance requirements and select the proper equipment.
- ◆ The manufacturer's instructions shall be provided to users with this product. Read all instructions and warnings provided by Buckingham and included with the product as well as instructions supplied with all associated equipment.
- ◆ Wood Pole Fall Restriction Devices must be in proper adjustment before use.
- ◆ All Wood Pole Fall Restriction Devices **MUST BE** properly adjusted and used in accordance with the manufacturer's instructions to function as designed and intended. Failure to do so could result in serious injury or death.
- ◆ Visually inspect the BuckSqueeze-Lite™ and all related equipment before each use. (See inspection below).

INSPECTION:

Prior to use, carefully inspect equipment for indications of wear and / or deterioration. The inspection should include, but not be limited to the following:

1. All hardware and connecting devices are clean and functioning properly, free of cracks, deformation, burrs, excessive wear, corrosion, modifications or additions. Serrated Rotosnap and Carabiner gate freely opens and closes without binding. All bolts and locking nuts are in place and securely tightened. Note: the gate of the Serrated Rotosnap is manufactured with a spring retention slot (Fig. 8). Ensure this slot is free from debris as this may cause the gate to bind. Ensure the rubber grip attached to the gate of the Serrated Rotosnap is centered in the knurled section of the gate as shown.
- 
- Spring retention slot
- Fig. 8**
2. The cams of the WebGrab and BuckGrab rotate freely and lock on the strap / rope when properly adjusted on the pole and the user's weight is on the unit.
 3. WebGrab and BuckGrab Cams lock so that there is no slippage when the Outer Strap (brown neoprene impregnated nylon) is pulled in the direction away from the WebGrab / Handle. BuckGrab securely grips the inner rope when under tension.
 4. Metal Strap End Clip Rivets are properly peened and tight and hardware is secured to the strap.
 5. Carabiners: comply with the User Guide for Connectors (located near the end of this document).
 6. Bolt Inspection: Component connecting bolts and frames have been designed and manufactured from high grade aluminum and hardened steel to minimize the possibility of excessive wear and or damage. Evidence of bolt wear may be indicated by excessive play between the bolt and mounting holes. Evidence of bent bolts may be indicated by sticking or binding Roller of Cams. Cams should freely rotate around bolts when bolts are held in place. If evidence of wear or damage are present or you are unsure, the unit should be removed from service and returned to Buckingham Mfg. for inspection.
 7. The Outer Strap and inner rope are free from obstructions including kinks, knots, cuts, cracks, burns, abrasions, broken strands, excessive wear, chemical exposure and ice, mud, snow, etc. buildup. If buildup on straps or component assemblies is noted, remove buildup. One method of removal from the straps is to run the WebGrab along the length of the outer (brown) strap and the BuckGrab along the length of the inner rope. Ensure component assemblies are clean and free of any debris. **NOTE: Prior To and While in Use, particularly in extreme weather conditions (i.e., blizzards, high winds, etc.)** - guard against debris (pebbles, twigs, packed snow, ice, mud, etc.) becoming lodged in any of the component assemblies as well as any buildup on the straps, as debris / buildup could block or restrict proper function. If noted, ensure the unit is cleared. Test for slippage by connecting and properly adjusting the BuckSqueeze-Lite™ to the pole and your body belt. While grasping the pole, shift your weight into the BuckSqueeze-Lite™. The BuckSqueeze-Lite™ should cinch tightly around the pole verifying its adequacy for ascent or descent.
 8. Both the Inner rope and Outer Straps are not worn to the point of showing the red warning center.
 9. If using a woven positioning strap with the WPFRD, see positioning strap instructions (PN 230193) supplied with product.
 10. If using a Buck-A-Juster (rope positioning / restraint line) with the WPFRD, see Buck-A-Juster instructions / warnings (PN 230194) supplied with product.
 11. If using a BuckLeverJust (Fig. 9) (adjustable positioning lanyard) with the WPFRD, see BuckLeverJust instructions / warnings (PN 230194) supplied with product.

BUCK LeverGrab™ LENGTH ADJUSTING DEVICE (LAD) INSPECTION:

- Unit is free of cracks – (usually depicted by fine jagged lines) and extensive wear or corrosion to cam, or housing.
- Lanyard is properly installed into LAD, snap end of lanyard exits the LAD with the anchor arrow facing the pole (shown at right).
- Proper operation of mechanism by pivoting release lever back and forth. Movement must be unrestricted with no binding. Binding could be caused by burrs, packed snow, or ice.
- Ensure all bolts, nuts and screw are properly in place and tightened.

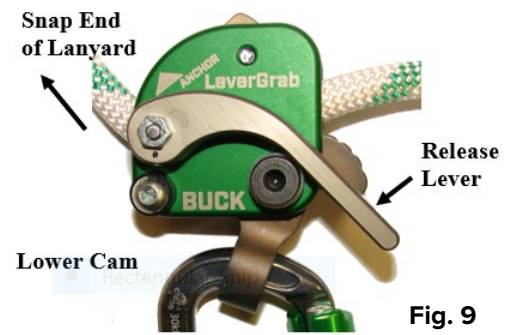

Remove from service, destroy, discard and replace immediately any unit that does not pass the above inspection.

OPERATION:

1. HOW TO MOUNT THE BUCKSQUEEZE-LITE™ ON THE BODY BELT:

- The user must connect the Inner Rope locking carabiners to each of the body belt D-ring (Fig. 10). With each use, visually check that Carabiners freely engage the body belt D-rings and that the gate is completely closed and facing outward. Never rely solely on the feel or sound of a snaphook or carabiner engaging.
- If using a Stacked, In Line or Multi Hole D-ring Body Belt follow your company's specified work practice, as well as the attachment instructions and warnings that were supplied with those Body Belts.



Fig. 10

2. HOW TO MOUNT THE BUCKSQUEEZE-LITE™ ONTO THE POLE TO BEGIN:

The BuckSqueeze-Lite™ can be mounted on the pole for either a left hand or right-hand person. The user can hold the Serrated Rotosnap in either the right or left hand and the WebGrab / Handle in the opposite. With the Serrated Rotosnap disconnected from the Nose D-ring, wrap the Outer Strap around the back of the pole and re-connect the Serrated Rotosnap to the Nose D-ring. **Notes:** Proper operation requires gate to be fully rotated prior to opening.



Fig. 11



Fig. 12

Serrated Rotosnap mounted on the right side of the pole (Fig. 11). Serrated Rotosnap mounted on the left side of the pole (Fig 12).

User's Choice

3. HOW TO ADJUST THE LENGTH OF THE OUTER STRAP:

Once the BuckSqueeze-Lite™ is fastened around the pole, the position of the hardware components on the pole is critical for proper operation. The Web Grab Cam is attached to the WebGrab frame with a nut and bolt. The Serrated Rotosnap is manufactured with a raised rib near the second serration from the webbing slot. The nut & bolt and rib are designed to be used as hardware locator markings to help identify proper placement of the BuckSqueeze-Lite™ on the pole. (See Fig. 13a – 13c below).

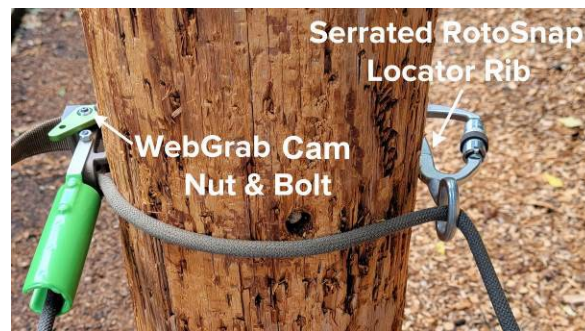

Fig. 13a

WebGrab Cam Nut & Bolt (locator) Fig. 13b



Serrated Rotosnap (locator rib) Fig. 13c



Consider the circumference of the pole to be the face of a clock. Place the nut or bolt of the WebGrab Cam at the 3:00 or 9:00 o'clock position on one side and the locator rib of the Serrated Rotosnap at either the 3:00 or 9:00 o'clock position on the opposite side of pole (See Figures 13b & 13c).

Ideal Placement – 3 and 9 o'clock positions. Never allow locators to fall within the hazardous zone defined by the 4:00 to 8:00 o'clock positions. (See Figures 14 & 15)

To adjust the Outer Strap (brown neoprene impregnated nylon) to the proper circumference, compress the WebGrab Cam and move the Outer Strap until the hardware is properly located on the pole as outlined in Figures 13a -13c.

Fig. 14



Fig. 15



HAZARDOUS

Two important reasons to properly adjust the hardware around the pole are:

- a.) In the event of a cut out, if the hardware can come together, it will not squeeze the pole and will not stop the fall.
- b.) Comfort. If the hardware is mounted on the sides of the pole at the (3:00 and 9:00 o'clock position), the Inner Rope comes straight out (Fig. 16), eliminating the small 'V' created (Fig. 17) if the hardware is positioned beyond the halfway point and reduces pressure on the hips.

**Fig. 16
Correct**

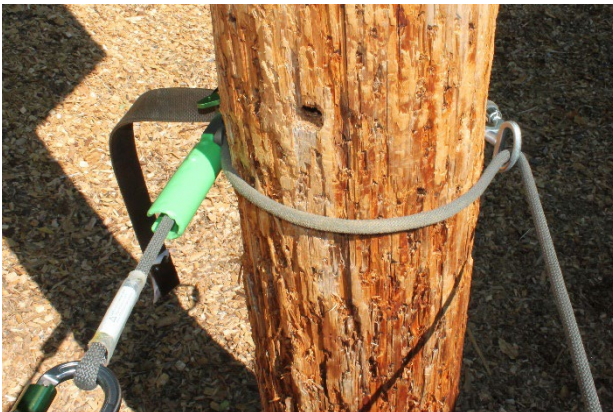

**Fig. 17
Incorrect**

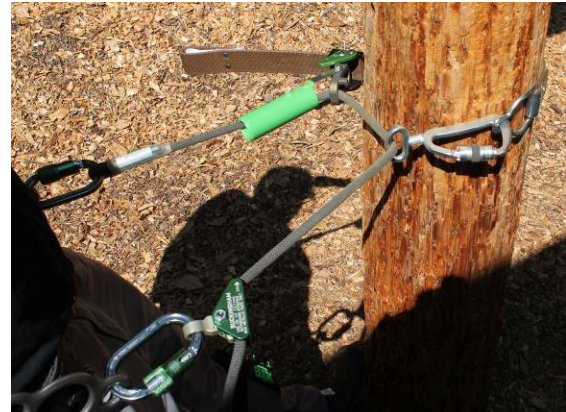

4. HOW TO ADJUST THE INNER ROPE:

- a.) The Inner Rope should be continually snug around the pole at all times. To make the rope longer (to go out to the end of a cross arm or to put the user further away from the pole) place one hand behind the pole and lean slightly toward the pole taking tension off the rope, then depress the BuckGrab Cam and slowly and slightly lean back into the BuckSqueeze-Lite™ until you pull enough rope through the BuckGrab to have the desired length (Fig. 18). Release your grip on the cam once desired length is obtained.



Fig. 18

- b.) To shorten the Inner Rope, place one hand behind the pole and lean slightly toward the pole taking tension off the rope and with the other hand, grab the free end of the rope pulling it through the BuckGrab toward the pole, until you have the desired length (Fig. 19).



Fig. 19

5. HOW TO ADJUST THE BUCKSQUEEZE-LITE™ TO CLIMB:

- a.) Attach both locking carabiners of the BuckSqueeze-Lite™ to the D-rings of your body belt ensuring the gates are completely closed and facing outward.
- b.) Place the BuckSqueeze-Lite™ around the pole so the position of the locators of the two hardware components are at the 3:00 and 9:00 position.
- c.) While standing on the ground at the base of the pole and the BuckSqueeze-Lite™ even with the D-rings of your body belt, adjust the Inner Rope so you are in an ideal climbing position. This is typically measured by placing your elbow into your stomach with fingers outstretched touching the pole.

6. HOW TO HOLD THE BUCKSQUEEZE-LITE™ WHEN READY TO CLIMB:

- a.) Just prior to initiating the climb, grasp the WebGrab Handle and Inner Rope in one hand (Fig. 20), and the Serrated Rotosnap in the other hand (Fig. 21). Spread the hardware approximately 1" away from the pole and lift the BuckSqueeze-Lite™ to chest height. (NOTE: the BuckSqueeze-Lite™ should be kept snug).



Fig. 20



Fig. 21

7. HOW TO HITCHHIKE:

- a.) To initiate the ascent, set the 1st climber gaff approximately 10" up and the 2nd climber gaff approximately 10" above the first. Then with the gaffs set, flip the BuckSqueeze-Lite™ up to chest height using either forearm and elbow motion or shoulder and arm motion.
- b.) With the BuckSqueeze-Lite™ cinched around the pole at chest height take a short step or two with climbers to ascend. Then with the gaffs set, again flip the BuckSqueeze-Lite™ up to chest height. Repeat procedure until reaching desired position.

Note: The Inner Rope must always be snug around pole when climbing. In addition, shortening the rope so that the user is closer to the pole and by flipping the BuckSqueeze-Lite™ shorter distances make climbing less strenuous. Flipping the rope approximately the same distance that you can bend your elbows may reduce stress on your body.

→
Fig. 22 -waist



Fig. 23 - chest

→
Keep BuckSqueeze-Lite™ between the waist and chest as you hitchhike (Fig. 22 & 23).



8. ADJUSTING THE CIRCUMFERENCE OF THE BUCKSQUEEZE-LITE™

- a.) Pole circumference changes encountered as you ascend or descend the pole requires outer strap length adjustment to keep the hardware locators in the 3 and 9 o'clock positions.
- b.) To shorten, lean slightly into the pole to relieve pressure on the BuckSqueeze-Lite™ and pull the end of the Outer Strap away from the pole (Fig. 24).
- c.) To lengthen, lean slightly into the pole to relieve pressure on the BuckSqueeze-Lite™, slightly depress the WebGrab Cam and slowly lean back into the BuckSqueeze-Lite™ to lengthen (Fig. 25).

Fig. 24



Fig. 25



9. LANYARD OPTIONS FOR CLIMBING OVER OBSTRUCTIONS

- a.) When the user ascends or descends the pole and comes to an obstruction, a secondary lanyard is required. Buckingham offers three options:
 - i. Option 1 is a Buck-A-Juster adjustable positioning lanyard with a length adjustment device.
 - ii. Option 2 is a woven web strap with friction buckle adjustment
 - iii. Option 3 is a Buck LeverJust™.
- b.) If using a secondary lanyard with a Stacked, In Line or Multi Hole D-ring Body Belt follow your company's specified work practice, as well as the attachment instructions and warnings that were supplied with those Body Belts.

Option 1



Option 2



Option 3



10. HOW TO CLIMB OVER AN OBSTRUCTION DURING AN ASCENT WITH A SECONDARY LANYARD OR STRAP.

Ensure secondary lanyard device is properly attached to body belt. (Always read carefully, understand, and heed all instructions and warnings included with that device and body belt before using this equipment). To ease transitioning over obstructions, step up the pole so chest position is approximately at the same height as the top of the obstruction if possible.

- a.) With obstruction at approximately chest height, adjust secondary lanyard to length so that it will pass around the pole, over the obstruction and back to the opposite side body belt D-ring (Fig. 26).
- b.) Place the secondary lanyard around the pole, over the obstruction and connect the snaphook or carabiner back to the appropriate body belt D-ring (Fig. 27). Take a couple of steps up and minimize the fall distance by re-adjusting the length of the secondary lanyard.
- c.) Once the secondary lanyard is secured over the obstruction, adjust the WPFRD by compressing the WebGrab Cam and lengthen the Outer Strap and disconnect the Serrated Rotosnap from the Nose D-ring. Place the Outer Strap and Inner Rope of BuckSqueeze-Lite™ on top of the secondary lanyard or over your shoulder so both hands are free (Fig. 28).



Fig. 26



Fig. 27



Fig. 28

- d.) Place Outer Strap around the pole and over the obstruction and the secondary lanyard and then reconnect the BuckSqueeze-Lite™ (Fig. 29).

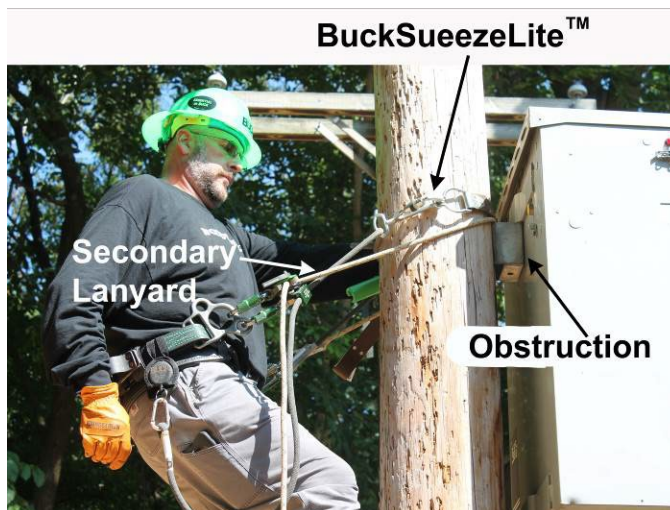

Fig. 29

- e.) Adjust the Outer Strap so the hardware locators are at the 3 and 9 o'clock positions ensuring that the Inner Rope is snug to the pole (Fig. 30 & 31). (See instruction number 3 for more details).
- f.) Once the BuckSqueeze-Lite™ is properly secured, lengthen the adjustment of the secondary lanyard transferring your weight back into the BuckSqueeze-Lite™, then disconnect the secondary lanyard above the obstruction stow it to your body belt and continue the ascent (Fig. 32).



Fig. 30



Fig. 31



Fig. 32

11. HOW TO DESCEND PAST AN OBSTRUCTION WITH A SECONDARY LANYARD OR STRAP.

Ensure secondary lanyard device is properly attached to body belt. (Read carefully, understand and heed all instructions and warnings included with that device and body belt before using this equipment).

- a.) As the user descends and comes to an obstruction, adjust secondary lanyard to length so that it will pass around the pole, over the obstruction and back to the opposite side body belt D-ring (Fig. 33).
- b.) Then simply secure the secondary lanyard around the pole and above the obstruction and below the BuckSqueeze-Lite™. Connect the secondary lanyard snaphook or carabiner back to the appropriate body belt D-ring. Minimize the fall distance by re-adjusting the length of the secondary lanyard (Fig. 34).
- c.) With the secondary lanyard secured, compress the BuckSqueeze-Lite™ WebGrab Cam to lengthen the Outer Strap of the BuckSqueeze-Lite™ to ease removal and disconnect the BuckSqueeze-Lite™ Serrated Rotosnap from the Nose D-ring.
- d.) Refasten the BuckSqueeze-Lite™ below the obstruction and readjust it so the hardware locators are set at the 3 and 9 o'clock positions and readjust the Inner rope until snug (Fig. 35). (See instruction numbers 3 & 4 for more details).
- e.) Once the BuckSqueeze-Lite™ is properly secured, lengthen the adjustment of the secondary lanyard transferring your weight back into the BuckSqueeze-Lite™ and disconnect the secondary lanyard from above the obstruction stow it to your body belt and continue the descent (Fig. 36).



Fig. 33



Fig. 34



Fig. 35



Fig. 36

12. HOW TO PERFORM A HURTMAN RESCUE

Note: Extreme caution must be taken when practicing or performing hurt man rescue as the rescuer may need to position their BuckSqueeze-Lite™ near the victims WPFRD. Always visually ensure the strap or rope you are about to cut is that of the victim's unit not yours. Keep your unit as far from the victims as possible.

- Once the victim has been secured using the method described by user's employers' safety practice, either the Outer Strap (brown neoprene impregnated nylon) or the Inner Strap (woven web or rope) may be cut to release the victim from the pole.
- Generally, the Inner rope will have a gap and be easier to cut (Fig. 37).
- Ensure the victim has been properly secured as outlined by user's employers' safety practice prior to cutting either strap.



Fig. 37

Example: Cut Strap or Rope here for hurt man rescue

13. INSTRUCTIONS FOR USING THE BUCKSQUEEZE-LITE™ WITH A HANDLINE.

Under certain circumstances a hand line may come into contact with the gate of the Serrated Rotosnap. Pulling the hand line up under these circumstances (Fig. 38), may cause the gate to rotate and open thus allowing the hand line to transfer inside the Serrated Rotosnap (Fig. 39). Although inconvenient, we do not believe it to be a safety hazard. The hand line can be easily removed and repositioned from the Serrated Rotosnap.

If using a hand line attached directly to the pole while using the BuckSqueeze-Lite™, one of the following actions can be initiated to eliminate the aforementioned potential:

- Position the Serrated Rotosnap opposite the hand line.
- Shift the position of the Serrated Rotosnap forward or backwards (while maintaining proper adjustment).
- Reposition the hand line so it does not come into contact with the gate of the Serrated Rotosnap.



Fig. 38



Fig. 39

14. INSTRUCTIONS FOR USING THE BUCKSQUEEZE-LITE™ ON WOOD POLES WITH U- SHAPED GUARD / CONDUIT ATTACHED.

The BuckSqueeze-Lite™ has been tested in accordance to applicable wet pole with conduit test sections of the ASTM F887-23 and CSA Z259.14-12 standards (type A criteria) using a 3 3/4" maximum U – shaped galvanized steel guard mounted to the pole (as shown in Fig. 40) to simulate pole conditions with both U-shaped guards and conduit attached.

Based on these test results and previous testing we have approved the BuckSqueeze-Lite™ for use on poles with attached 3 1/8" U-shaped guard or conduit only when the unit is placed at waist level or above and used by a worker with a maximum weight of 350 lb. when fully equipped. Additionally, placement of the BuckSqueeze-Lite™ on these types of poles needs to be specific in order for the system to adequately perform.

One approved position is with the U-shaped guard or conduit located directly in front of the end user (Fig. 41). The other approved position is with the U-shaped guard or conduit directly behind the pole (Fig. 42). The U-shaped guard or conduit must be at either the o'clock 6 or 12 o'clock position in relation to the user when the pole is viewed as the face of a clock.

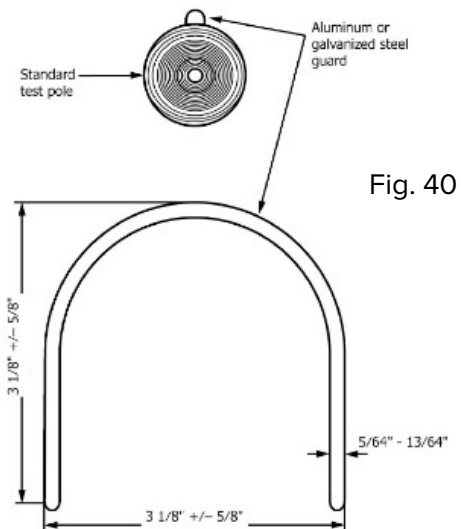

Fig. 40

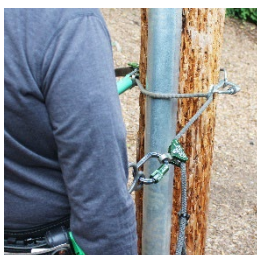

Fig. 41

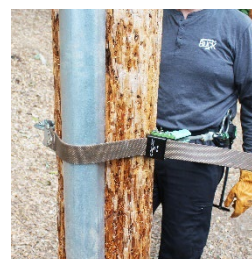

Fig. 42



Fig. 43



Fig. 44

The BuckSqueeze-Lite™ hardware (Serrated Rotosnap - Fig. 43 or WebGrab Grippers - Fig. 44) must not be located on or come into contact with U-shaped guards, conduit or any other object that may be mounted to the pole. When the BuckSqueeze-Lite™ is mounted over U-shaped guard or conduit ensure that the unit is properly adjusted so that the hardware (Serrated Rotosnap or WebGrab Grippers) make contact with the pole.

15. INSTRUCTIONS FOR CHANGING THE LOCATION OF OR INSTALLING THE WebGrab BuckHorn.

Notes: The BucksqueezeLite™ series is supplied with a WebGrab BuckHorn (Fig. 45) installed and facing up when the BucksqueezeLite™ is installed on the pole with the WebGrab on your left side as you face the pole. Follow steps (a-h) below to install the WebGrab BuckHorn on the opposite side (top) of the WebGrab, when the BucksqueezeLite™ is installed on the pole with the WebGrab on your right side as you face the pole.

The WebGrab body has threaded holes on each side for easy attachment of the WebGrab BuckHorn. Follow the steps below to attach a WebGrab BuckHorn to either side of the WebGrab body.

- Using a 3/16" hex wrench, remove the 5/16" button head cap screw that secures the WebGrab BuckHorn to the WebGrab body (Fig. 46-47). Discard the removed button cap screw.
- Remove the WebGrab BuckHorn (Fig. 48).
- Flip the entire BucksqueezeLite™ over so WebGrab is positioned on your right side (Fig 49).
- Position the WebGrab BuckHorn onto the WebGrab body as shown (Fig. 50). Note: The center hole in the WebGrab BuckHorn is designed to slip over the WebGrab cam bolt and nut when installed in the WebGrab (Do Not Remove the Cam Bolt or Nut).
- Install the new included 5/16" button head cap screw with thread sealant patch through the WebGrab BuckHorn and into the WebGrab body (Fig 51).
- Using a 3/16" hex wrench tighten the 5/16" button head cap screw securing the BuckHorn to the WebGrab (Fig. 52) (Do Not Over Tighten).
- The BucksqueezeLite™ is now ready for use with the WebGrab on the right side of the pole as you face it.



Fig. 45



Fig. 46



Fig. 47



Fig. 48



Fig. 49



Fig. 50



Fig. 51



Fig. 52

WARNINGS:

- ◆ Read carefully, understand, and heed these instructions and warnings before using this equipment. Failure to do so could result in your serious injury or death.
 - ◆ This equipment is intended for use by properly trained professionals only.
 - ◆ Please consult with your physician prior to using this product. Do not use this product under the influence of drugs or alcohol.
 - ◆ This product is designed to be used by a person with a maximum weight of 350 lbs. when fully equipped.
 - ◆ Wood Pole Fall Restriction Devices must be in proper adjustment before use.
 - ◆ All Wood Pole Fall Restriction Devices **MUST BE** properly adjusted and used in accordance with the manufacturer's instructions to function as designed and intended. Failure to do so could result in serious injury or death.
 - ◆ Inspect all poles prior to climbing to ensure that there are no service wires running vertically up the pole. If wires are present install U-guard over the wires or de-energize the circuit prior to installing the BuckSqueeze-Lite™.
 - ◆ Never place or let the BuckSqueeze-Lite™ hardware (Serrated Rotosnap or WebGrab Grippers) come into contact with U-shaped guards, conduit or any other object that may be mounted to the pole that would prevent the hardware from making contact with the wood.
 - ◆ Fall protection equipment, (i.e. fall arrest, work positioning, climbers, retrieval, suspension etc.) should not be resold or provided to others for re-use after use by original user as assurance cannot be granted that a used product meets criteria of applicable standards and is safe for use to a subsequent user.
 - ◆ Only Buckingham Mfg. Co. or those people authorized in writing by Buckingham Mfg. Co. may make repairs to this equipment.
 - ◆ Inspect your equipment prior to each use. As a minimum, use all inspection instructions included in this document.
 - ◆ Be certain this equipment is suitable for the intended use and work environment. It should only be used as personal protection equipment (PPE). If suitability for intended use is in doubt, consult a safety engineer or contact Buckingham Mfg. before using.
 - ◆ The selection of products should be such that they aid the worker in the performance of his/her job and particular work situation. Therefore, be certain this equipment is suitable for the intended use and work environment. It should only be used as personal protection equipment. If suitability for intended use is questionable, always consult your Supervisor, Safety Director or contact Buckingham Mfg. at (607) 773-2400 or 1-800-937-2825.
 - ◆ Be certain the Outer Strap is properly positioned on the pole and the Inner Rope is snug to the pole.
Failure to heed this warning will result in inadequate gripping capabilities of the unit.
 - ◆ **Never hold the BuckSqueeze-Lite™ open while climbing; doing so could result in inadequate gripping capabilities of the unit.**
 - ◆ A secondary fall protection device must be used when the Outer Strap is disconnected to relocate it above or below an obstruction on the pole.
 - ◆ Before use, ensure locking mechanisms of Locking Carabiners and Serrated Rotosnap are functioning properly. Never disable locking mechanisms or gates, punch holes in or alter a connecting device or this product in any way.
 - ◆ Make sure each carabiner and the Serrated Rotosnap is positioned so that its keeper / gate is never load bearing.
 - ◆ With each use, visually check that the carabiners freely engage the body belt D-rings and that the gate is completely closed and facing outward. Never rely solely on the feel or sound of a carabiner engaging.
 - ◆ With each use, visually check that the Serrated Rotosnap engages the Nose D-ring and that the gate is closed and facing outward. Never rely solely on the feel or sound of the Serrated Rotosnap engaging.
 - ◆ With each use, visually check that the rubber grip attached to the gate of the Serrated Rotosnap is centered in the knurled section. A rubber grip that has slid out of the knurled center section and towards the top (Fig. 53) or bottom (Fig. 54) of the gate may prevent the gate from properly closing and locking.
 - ◆ When in the work position, ensure there is no pressure on the locking carabiner gates as this may cause accidental disengagement.
 - ◆ **Never let the WPFRD fall below waist level while ascending, descending or working.**
- NOTE:** In certain transitioning situations, while ascending above or descending below obstructions such as cross arms or transformers, cable battery relay boxes, working on a faulty cut out, etc. it may be necessary to position the WPFRD below the waist. However, never allow the BuckSqueeze-Lite™ to be positioned below the waist without first placing the secondary positioning strap above the obstruction.
- ◆ The slot of the Nose D-ring is designed and intended for connection of the Serrated Rotosnap only, never attach anything other than the Serrated Rotosnap to the nose D-ring.
 - ◆ **Never allow the Web Grab / Handle Assembly and the Serrated Rotosnap to come into contact with each other.**
 - ◆ Ensure all connections are complete and proper before climbing.
 - ◆ For personal use only. NOT for towing or hoisting.
 - ◆ If a fall or impact loading has occurred the WPFRD should be removed from service and returned to Buckingham Mfg. for inspection or inspected by a trained, qualified and user's company approved inspector.
NOTE: Unit must be taken out of service and replaced if there is any question regarding it being safe for use.
 - ◆ All affixed labels should be left in place and all instructional material should be kept for future reference.
 - ◆ Avoid contact of this equipment with sharp edged or pointed tools, hand saws, chainsaws, hand tools, abrasive surfaces, high temperature surfaces, welding or other heat sources, electrical hazards, chemicals, moving machinery etc.
 - ◆ Be aware of this device's position / placement at all times in relation to the operations being performed. Use extreme caution when performing operations such as cutting, drilling, sawing, etc. Always perform this type of work well above this device to avoid the potential of tool contact, causing damage which may result in a fall, serious injury or death).
 - ◆ When performing a Hurt Man Rescue, be aware of your device's position / placement in relation to the victim's device. Visually ensure the strap or rope you are about to cut is that of the victim's device, not yours.
 - ◆ Never work without independent fall protection if there is danger of a fall.
 - ◆ Never transfer from a ladder to wood pole, steel pole or other structures or vice versa.



Fig. 53



Fig. 54

- ◆ Ensure a rescue plan and resources are in place before climbing.
- ◆ Employer – instruct employee as to proper use and warnings before use of equipment.
- ◆ BuckSqueeze-Lite™ meets or exceeds requirements of OSHA 1926.502(e), CSA Z259.14-12 (Type AB) and ASTM F887 (Type AB) as manufactured and through proper use of product when used on round poles.
- ◆ Product covered under these instructions / warnings should not be resold / redistributed or re-used after use by original user.
- ◆ The pole to be climbed must have a minimum diameter of 5 inches (127 millimeters) or a minimum circumference of 15.75 inches (400 millimeters). This measurement must be taken when the WPFRD is above the user's waist.

CLEANING: Proper maintenance and storage of your equipment will prolong its useful life and contribute toward its performance. The equipment should be cleaned and maintained at regular intervals depending on usage.

Nylon - Clean with water and mild soap (a dish washing soap that removes grease (such as Dawn) and allow to dry thoroughly without using excessive heat. It may be helpful to gently scrub using a soft brush prior to rinsing. Do not use any type of corrosive substance or acid, which will gradually degrade the fabric.

STORAGE: Store in a dry environment, away from chemicals, excessive heat and direct sunlight. Buckingham Mfg. Co. recommends using storage bag part number 45500G1, to store the 486 Series device.

LUBRICATION: Lubricate carabiner gates at least weekly or as often as required to maintain smooth operation (no binding). Use a lightweight lubricant such as WD-40®.

NOTE: Ensure proper fit / size of product before use. This product cannot be returned unless it is in new / unused condition. Patent Pending, for more information, visit BuckinghamMFG.com/Patents.

USER GUIDE FOR CONNECTORS

Typical Carabiner shown styles colors may vary (Fig. 55).



Fig. 55

• INSPECTION AND RETIREMENT CRITERIA:

All connectors must be inspected at time of purchase, before and after each use.

Inspections must ensure all surfaces of the connector to be free of cracks, deformation, sharp edges, corrosion, abrasion, burrs and excessive wear. It is surprising how easily a nick or burr in a carabiner, such as from being loaded on a square edge bolt, can damage textiles or your rope. Check the rivet and that the gate works smoothly, springing back to a fully closed position with good nose/gate alignment. There should be no excessive side-to-side play in the gate and if it is a locking carabiner the gate barrel should go through all motions smoothly and without any gritty/rubbing noises. Connectors that do not pass this inspection must be removed from service and destroyed.

• LIMITATIONS AND PROPER USE:

All connectors are designed and tested to specific load designations. Be aware of the designed load limitations and proper user technique. Do not overload a connector. Connectors can and will fail under improper use. If you are not sure of proper application or user technique, seek proper training in connector use and technical rope application.

• MAINTENANCE:

Keep connectors dry and clean. Do not store in humid or salty air, with damp clothing or near corrosive chemicals. To clean carabiners start by washing in lukewarm water with a mild detergent and using a soft bristle brush to remove stubborn grime and dirt. Pay particular attention to the body, hinge, nose, gate (open and closed) and the spring chamber. Rinse with lukewarm domestic supply water and dry off any excess with a lint free cloth. Air dry thoroughly at room temperature. It is very important to hang the carabiner with the gate opening uppermost, so that any water in the spring chamber is able to drain out.

Lubricate gate on both sides of connector after cleaning and at least weekly or as often as required to maintain smooth operation (no binding) with light weight lubricant such as WD-40®. Do not use graphite powder. For wire gate carabiners a drop or two of lubricant is simply required at the hinge. If using your gear in or near a marine environment you should always rinse, thoroughly dry and re lubricate your equipment. Carabiners should be stored out of direct sunlight or heat, in a well-ventilated space. Avoid leaving it at the bottom of a bag or other non-ventilated areas.

IF YOU HAVE ANY DOUBT CONCERNING THE USE OF THIS PRODUCT - DO NOT USE IT!

• WARNINGS:

- Serious injury or death could result from improper use of this component. Therefore, read and understand this guide before using this piece of auxiliary equipment.
- Special training and knowledge are required to use this equipment.
- Thoroughly read and understand all markings on and instructions included with this product before use!!!!
- Use and inspect this equipment in accordance with the manufacturer's instructions and applicable OSHA regulations.
- Do not file, engrave, etch or modify connectors for any reason.

- If a connector is dropped or impact loaded, return to the manufacturer of product that the connector is a part of or send to a qualified person for inspection.
- Refer to any additional product manufacturer's instructions that maybe furnished with the equipment before use. Contact Buckingham Mfg. Co. at 1-800-937-2825 should you have component / product inspection / findings / use questions.

STATEMENT of OBSOLESCENCE:

Precise "useful life expectancy" or "shelf life" for this product is not specified, as the degree of use, conditions of use, and the degree of care and storage determines useful life. All users maintain responsibility to select proper equipment for the job, be properly trained in its use, and ensure all personnel support equipment passes inspection before each use. Upon evidence of defects, damage or deterioration, all equipment shall be removed from service immediately and tagged or marked as unusable or destroyed. Additionally, all equipment shall be inspected on a regular basis not to exceed one year by a Competent Person, as defined by OSHA/ANSI, to verify that the equipment is safe for use. In the event of any question or concern regarding the condition of such equipment, users shall remove the equipment from service for further inspection. All users must comply with OSHA/ANSI/ASTM standards prior to and in using such equipment. For more information regarding safe and appropriate use of equipment, please contact Buckingham Manufacturing at 1-800-937-2825.

INTERNATIONAL USERS:

Notwithstanding the above, please know that certain international jurisdictions require manufacturers of equipment to provide customers with a maximum useful lifespan (sometimes referred to as a "Statement of Obsolescence"). To the extent required, Buckingham personal protective equipment manufactured from synthetic fiber materials including but not limited to items such as webbing and/or rope are subject to a maximum useful lifespan of ten (10) years from the date of manufacture. As stated above proper usage, storage, maintenance, and care impacts the useful lifespan of equipment. Extreme circumstances may require that product must be retired after only one use. This statement is made in conformance and compliance with BS EN 365:2004. International users must ensure that product inspections are completed by Competent Persons as defined by international standards including but not limited to British Standard ("BS"). If equipment fails any inspections, it must be immediately withdrawn from service and destroyed. For more information regarding safe and appropriate use of equipment, please contact Buckingham Manufacturing at 1-800-937-2825.

OUR GUARANTEE:

We guarantee the equipment we manufacture to be free from defects in material and workmanship. We will repair any equipment deemed to be defective which is returned to us by the original purchaser. However, this guarantee is void if any product is changed or altered in any way, or if the product is used in a manner other than for which it is intended. This express guarantee supersedes all other expressed or implied guarantees, obligations or liabilities. There are no implied warranties of merchantability or fitness for a particular purpose and as such, all implied warranties are specifically disclaimed.

LIMITATION ON LIABILITY:

In no event will Buckingham or buyer be liable to the other for lost revenues, lost profits or any other indirect, consequential, special or punitive losses or damages, however caused, whether in action for breach of contract, strict liability, tort, or otherwise, even if advised of the possibility of such losses or damages. In no event will Buckingham's liability exceed the total amount paid by the buyer to Buckingham for the product or equipment giving rise to such claim(s).

Please see other terms and conditions relating to this product at <https://buckinghammfg.com/terms-conditions/>

REGISTRATION:

Before use of the product, ensure to register and confirm the product at www.buckinghammfg.com/register.

**BUCKINGHAM MFG.
BINGHAMTON, NY
1-800-937-2825**

Information contained in these written instructions supersedes all other information (written, audio, video etc.) produced by Buckingham Mfg.