

BUCKINGHAM MFG.

INSTRUCTIONS / WARNINGS

488 SERIES – SuperSqueeze / 490 SERIES – EZSqueeze

SuperSqueeze and EZSqueeze Instructions

Warning: Do not use this product if you cannot understand and follow the instructions and warnings that come with it and complete all necessary functions.

488 SERIES – SuperSqueeze

DESCRIPTION:

- Model 488W – Wood Pole Fall Restriction Device (WPFRD) with Woven Inner Strap for Distribution Poles.
- Model 488W2 – Wood Pole Fall Restriction Device (WPFRD) with Woven Inner Strap and dual WebGrabs for Distribution Poles.
- Model 488TW – Wood Pole Fall Restriction Device (WPFRD) with Woven Inner Strap for Transmission Poles.
- Model 488TW2 – Wood Pole Fall Restriction Device (WPFRD) with Woven Inner Strap and dual WebGrabs for Transmission Poles.
- Model 488R – Wood Pole Fall Restriction Device (WPFRD) with Rope Inner Strap for Distribution Poles.
- Model 488RT – Wood Pole Fall Restriction Device (WPFRD) with Rope Inner Strap for Transmission Poles.

* Alternate hardware

A – Locking Carabiners

A* – Locking Snaphooks

B – Inner Strap (Woven Web)

C – Outer Strap (Brown Neoprene Impregnated Nylon)

D – WebGrab / LAD (Rectangular Eye)

E – D-ring

F – WebGrab / LAD (Oval Eye)

G – Serrated Rotosnap

H – Cleat (Permanently Attached)

I – Riveted End

J – Outer Strap Fold Over

K – Outer Strap Handle

L – Friction Buckle

M – Wear Guard

N – Inner Strap (Rope)

O – BuckGrab / LAD (Rope)

O* – LeverGrab™ / LAD (Rope)

P – Rope Tail

R – Plastic Fiber

S – Hook & Loop Retention Strap

T – Threaded hole to be used for retro-fit of WebGrab BuckHorn

Note: Hardware / colors may vary from shown.

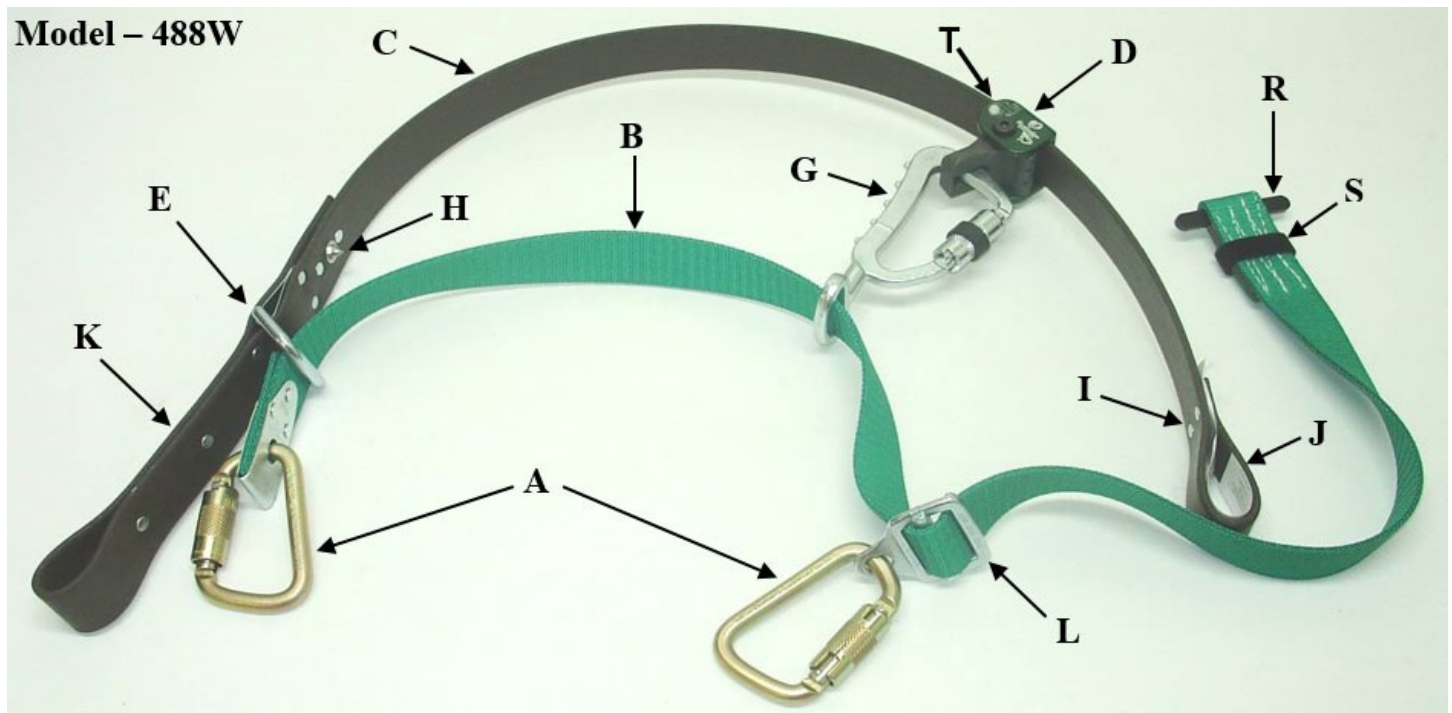

Model – 488W2

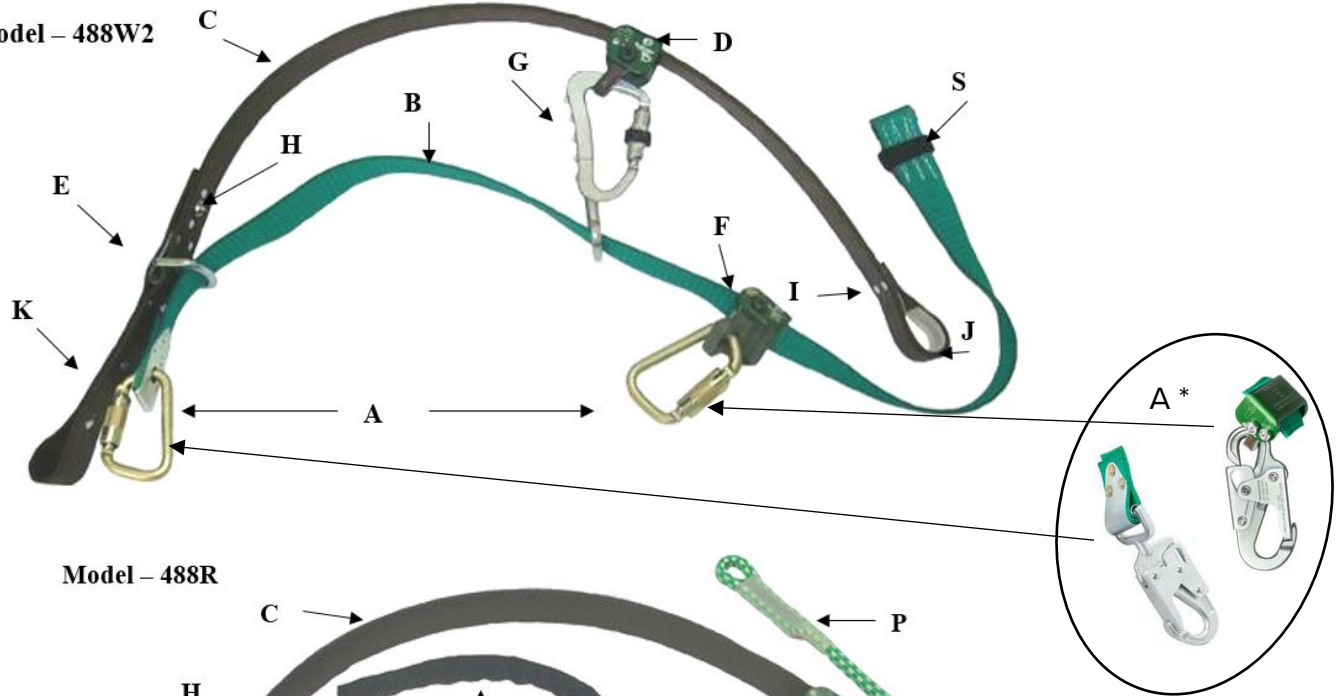

Model – 488R

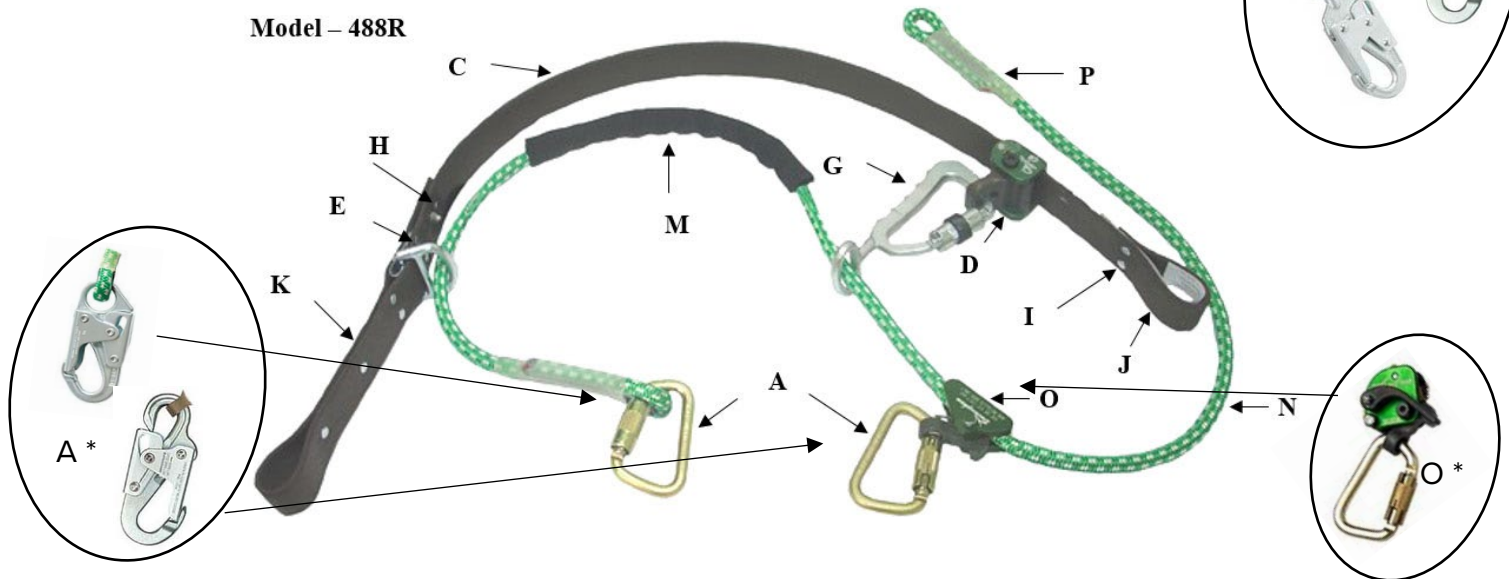

490 SERIES – EZSqueeze

DESCRIPTION:

- Model 490W2 – Wood Pole Fall Restriction Device (WPFRD) with BuckHorn on Outer Strap WebGrab and Outer Strap Loop Handle. Woven Inner Strap with WebGrab for Distribution Poles.
- Model 490TW2 – Wood Pole Fall Restriction Device (WPFRD) with BuckHorn on Outer Strap WebGrab and Outer Strap Loop Handle. Woven Inner Strap with WebGrab for Transmission Poles.
- Model 490R – Wood Pole Fall Restriction Device (WPFRD) with BuckHorn on Outer Strap WebGrab and Outer Strap Loop Handle. With Rope Inner Strap for Distribution Poles.
- Model 490RT – Wood Pole Fall Restriction Device (WPFRD) with BuckHorn on Outer Strap WebGrab and Outer Strap Loop Handle. With Rope Inner Strap for Transmission Poles.

* Alternate hardware

- | | | |
|--|---------------------------------|---------------------------------|
| A – Locking Carabiners | G – Serrated Rotosnap | P – Rope Tail |
| A* - Locking Snaphooks | H –Cleat (Permanently Attached) | S – Hook & Loop Retention Strap |
| B – Inner Strap (Woven Web) | I – Riveted End | T – Outer Strap Loop Handle |
| C – Outer Strap (Brown Neoprene Impregnated Nylon) | J – Outer Strap Fold Over | U –WebGrab BuckHorn |
| D – WebGrab / LAD (Rectangular Eye) | M – Wear Guard | |
| E – D-ring | N – Inner Strap (Rope) | |
| F – WebGrab / LAD (Oval Eye) | O – BuckGrab /LAD (Rope) | |
| | O* – LeverGrab™ / LAD (Rope) | |

Note: Hardware / colors may vary from shown.

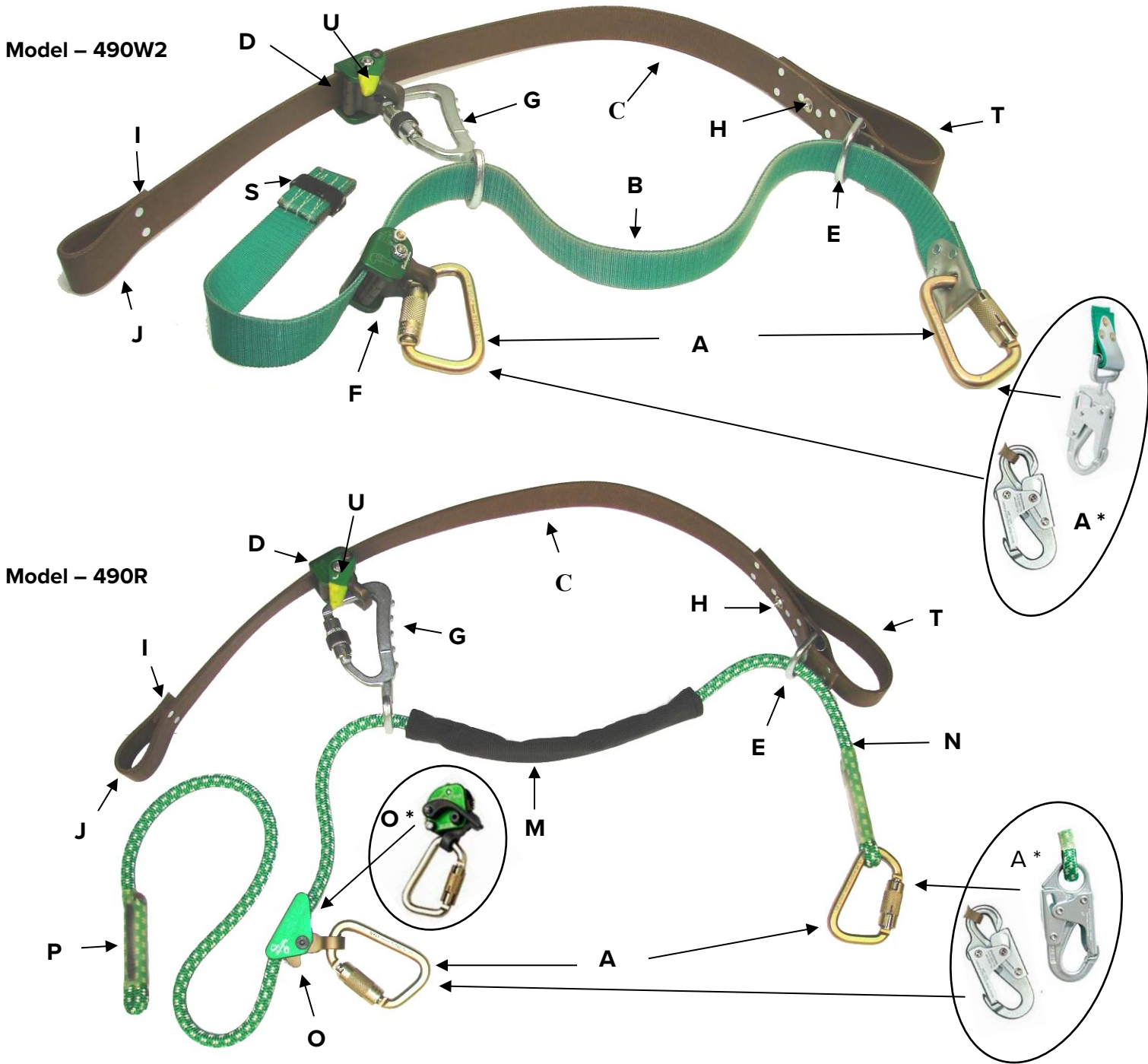

PN 5005T carabiners (Fig. A) included with SuperSqueeze and EZSqueeze carabiner versions include pre-drilled holes in the frame (Fig. B). These holes are intended for user installation of a PN 5005TC captive pin (not included) to make the carabiner non-removable from the eye of the LAD (Length Adjusting Device) or Rope / Webbing (Fig. C) of your SuperSqueeze / EZSqueeze device(s). The use of this pin is optional to the user.

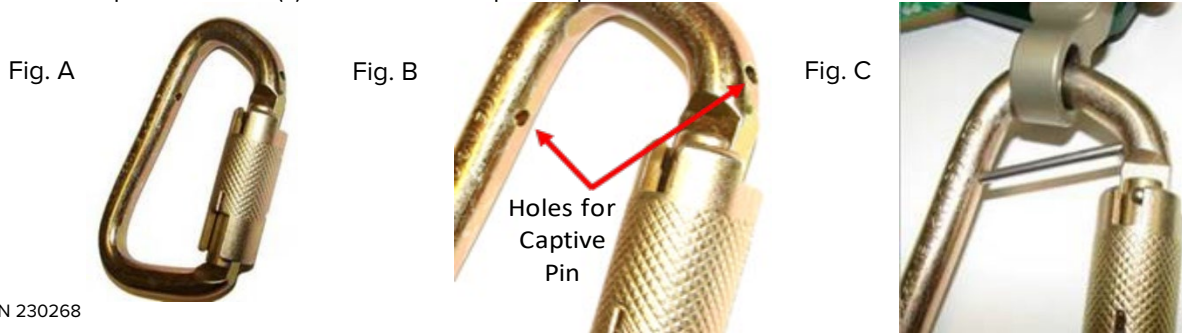

PRIOR TO USE:

- This equipment is intended for use by properly trained professionals only.
- Know the job and the regulations governing requirements and select proper equipment.
- Manufacturer's instructions shall be provided to users with this product. Read and understand all instructions and warnings provided by Buckingham included with the product before use.
- All Wood Pole Fall Restriction Devices **MUST BE** properly adjusted and used in accordance with the manufacturer's instructions to function as designed and intended. Proper adjustment of this device according to Buckingham's warnings and instructions is the user's responsibility. Death or serious injury may result to the user in the event that the device is used while out of adjustment.
- Visually inspect this, and all related equipment, before each use. (See inspection below)

INSPECTION:

Prior to use, carefully inspect equipment for indications of wear and/or deterioration. The inspection should be limited to the following:

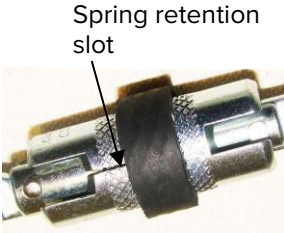
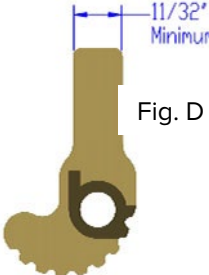
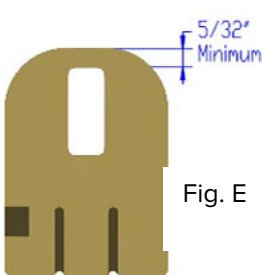
1. All hardware and connecting devices are clean and functioning properly, free of cracks, deformation, burrs, excessive wear, corrosion, modifications or additions. Saphook and Carabiner gate freely opens and closes without binding. All bolts and locking nuts are in place and securely tightened. Note: the gate of the Serrated Rotosnap is manufactured with a spring retention slot. Ensure this slot is free from debris as this may cause the gate to bind. Ensure the rubber grip attached to the gate of the Serrated Rotosnap is centered in the knurled section of the gate as shown.
- 
- Spring retention slot
2. The cams of the LADs rotate freely and locks on the strap / rope when properly adjusted on the pole and the user's weight is on the unit.
 3. The cam eye shows no signs of excessive wear. Slight wear from contact with the Serrated Rotosnap is acceptable. Unacceptable wear to the cam is defined as wear resulting in measured dimensions of less than 11/32" eye width (across the eye (Fig. D)) or less than 5/32" eye thickness at the top of eye (Fig. E) as defined by Buckingham's PN 6308 WebGrab / BuckGrab and OX BLOCK friction bar Gauge (sold separately).
- 
- Fig. D
- 
- Fig. E
4. All straps are free from defects including kinks, knots, cuts, cracks, burns, abrasions, broken strands or stitching, excessive wear, chemical exposure, and ice / mud / snow, etc., buildup. If buildup on straps or component assemblies is noted, remove buildup. One method of removal from the strap is to run the WebGrab along the length of the outer (brown) and inner (green / yellow) strap, and/or run the BuckGrab or LeverGrab™ along the length of the inner (rope) or the friction buckle along the length of the inner (green / yellow) strap. Ensure component assemblies are clean and free of any debris. **NOTE: Prior to and while in use, particularly in extreme weather conditions (i.e. blizzards, high winds, etc.)** – guard against debris (pebbles, twigs, packed snow, ice, mud, etc.) becoming lodged in any of the component assemblies as well as any buildup on the straps, as debris / build up could block or restrict proper function. If noted, ensure unit is clear. Test for slippage by connecting and properly adjusting the SuperSqueeze / EZSqueeze to the pole and your body belt. While grasping the pole, gradually shift your weight onto the SuperSqueeze / EZSqueeze. The SuperSqueeze / EZSqueeze should cinch tightly around the pole verifying its adequacy for ascent or descent.
 5. Both Inner and Outer Straps are not worn to the point of showing the warning center.
 6. The Cleat on the Outer Strap is in place. Do Not Use if this cleat is missing as unit will not function as designed.
 7. Rivets are not loose, or missing.
 8. Ensure the wear guard is in the correct location and not excessively worn.

Buck LeverGrab™ Length Adjusting Device (LAD) Inspection:

- Unit is free of cracks – (usually depicted by fine jagged lines) and extensive wear or corrosion to cam, or housing.
- Lanyard is properly installed into LAD, snap end of lanyard exits the LAD with the anchor arrow facing the pole (shown at right).
- Proper operation of mechanism by pivoting release lever back and forth. Movement must be unrestricted with no binding. Binding could be caused by burrs, packed snow, or ice.
- Ensure all bolts, nuts and screw are properly in place and tightened.

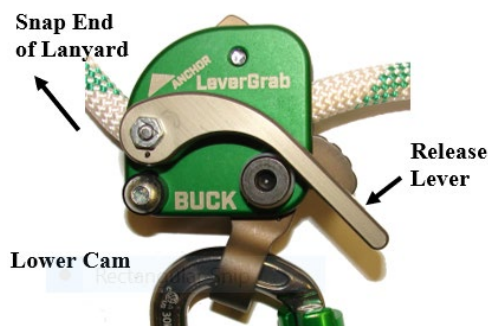

Remove from service, destroy, discard and replace immediately any unit that does not pass the above inspection.

OPERATION:

1. HOW TO MOUNT THE SUPERSQUEEZE / EZSQUEEZE TO THE BODY BELT:

- ◆ The user must connect each Locking Carabiner / Snaphook of the Inner Strap (Rope or Woven) to each of the body belt D-Rings. (Fig.1) With each use, visually check that Carabiners / Snaphooks freely engage the body belt D-rings and that the keeper / gate is completely closed. Never rely solely on the feel or sound of a snaphook or carabiner engaging.



2. HOW TO MOUNT THE SUPERSQUEEZE / EZSQUEEZE ONTO THE POLE TO BEGIN:

- ◆ The SuperSqueeze / EZSqueeze can be mounted onto the pole for either a right handed or left handed user. Note: Depending on its position, the EZSqueeze WebGrab BuckHorn may require relocation to suit. (See: “Instructions for changing the WebGrab BuckHorn location” section of these instructions). The User can hold the brown Outer Strap handle (SuperSqueeze) / Outer Strap Loop Handle (EZSqueeze) in one hand and the Serrated Rotosnap in the opposite hand. With the Serrated Rotosnap disconnected from the eye of the WebGrab cam wrap the outer strap around the back of the pole, slide the WebGrab from behind or the side of the pole towards your body until it can be clearly seen (Fig. 2a) and to ensure proper attachment of Serrated Rotosnap to the eye of the WebGrab. Then connect the Serrated Rotosnap to the eye of the WebGrab. With each connection, visually check that the Serrated Rotosnap engages the WebGrab cam eye and that the keeper / gate is completely closed and facing outward. Never rely solely on the feel or sound of the Serrated Rotosnap engaging.

Note: Proper operation requires gate of the Serrated Rotosnap to be fully rotated prior to opening.

Fig.2a



Users Choice

WebGrab / Serrated Rotosnap mounted on the right side of the pole (Fig. 2b).

or

Outer Strap Handle / D-ring mounted on the right side of the pole (Fig. 2c).



3. HOW TO ADJUST THE LENGTH OF THE OUTER STRAP (BROWN):

The position of the SuperSqueeze / EZSqueeze hardware components on the pole are critical for proper operation. The triangular rivet pattern on the D-ring side of the Outer Strap and the Serrated Rotosnap Locator Rib are used as locators to position the hardware on the pole (See Fig. 3a and 3b).

Triangular Rivet Pattern Fig. 3a



Serrated Rotosnap (Locator Rib) Fig. 3b

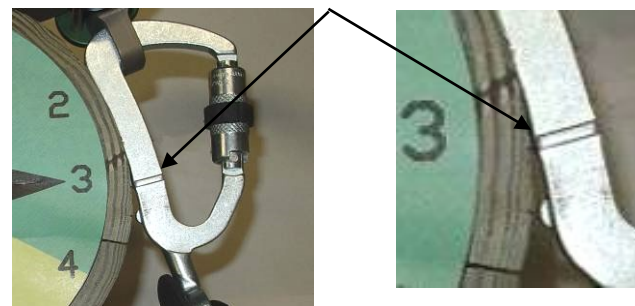

Consider the circumference of the pole to be the face of a clock. Place the triangular rivet pattern of the brown Outer Strap at the 3:00 or 9:00 o'clock position on one side and the Serrated Rotosnap Locator Rib at either 9:00 or 3:00 o'clock position on the opposite side (Fig.4)

Ideal Placements are at the 3 and 9 o'clock positions. Never allow the locators to fall within the hazardous zone defined between the 4:00 to 8:00 o'clock positions (see Fig.4).

To adjust the Outer Strap to the proper circumference, after mounting the SuperSqueeze / EZSqueeze onto the pole, slide the WebGrab along the brown Outer Strap until the hardware is properly located on the pole as shown in Fig.3a, 3b, and 4.

It is imperative that the hardware be properly adjusted around the pole (Fig 4a - 4b). Failure to do so (Fig 4c – 4d) could result in a fall.

Fig. 4



Fig. 4a



Correct Adjustment

Fig. 4b



Fig. 4c



Incorrect Adjustment

Fig. 4d



Note: When climbing, the WebGrab must be kept clear of all obstructions that could block the operation of the assembly.

4. A. HOW TO ADJUST THE INNER STRAP (WOVEN WEB) USING THE WEBGRAB

(The Inner Strap should be continually snug around the pole at all times.)

1. To lengthen the strap, (to go out to the end of a cross arm or to put the user further away from the pole) place one hand behind the pole and lean slightly toward the pole taking tension off the strap to relax tension on the WebGrab. Gradually depress the WebGrab Cam towards the pole, while slowly leaning back, until you have adjusted to your desired length. (See Fig. 5)
2. To shorten the strap, place one hand behind the pole and lean slightly towards the pole while pulling the free end of the strap through the WebGrab, until you have adjusted it to your desired length. (See Fig. 6)

Fig. 5



To Lengthen



To Shorten

Fig. 6

B. HOW TO ADJUST THE INNER STRAP (WOVEN WEB) WITH FRICTION BUCKLE

(The Inner Strap should be continually snug around the pole at all times)

1. To lengthen the strap, (to go out to the end of a cross arm or to put the user further away from the pole) place one hand behind the pole and lean slightly toward the pole taking tension off the strap. Next, pull back on the Friction Buckle to obtain your desired length (See Fig. 7).
2. To shorten the strap, place one hand behind the pole and lean slightly toward the pole taking tension off the strap. Next, pull the end of the strap through the Friction Buckle toward the pole, until you have the desired length (See Fig. 8).



To Lengthen



To Shorten

Fig. 8

C. HOW TO ADJUST THE INNER STRAP / ROPE (Using BuckGrab™ or LeverGrab™)

(The Inner Strap (Rope) should be continually snug around the pole at all times)

1. To lengthen the strap, (to go out to the end of a cross arm or to put the user further away from the pole) place one hand behind the pole and lean slightly toward the pole taking tension off the strap to relax tension on the BuckGrab or LeverGrab™. Gradually depress the BuckGrab Cam towards the pole, or the release lever of the LeverGrab™ towards your body while slowly leaning back until the rope feeds through the LAD and you have adjusted to your desired length. (See Fig. 9 BuckGrab shown) Release the cam or lever to stop at your desired position.

2. To shorten the strap, place one hand behind the pole and lean slightly towards the pole while pulling the free end of the Rope through the BuckGrab / LeverGrab™ until you have adjusted it to your desired length. (See Fig. 10)



To Lengthen



To Shorten

5. HOW TO ADJUST THE SUPERSQUEEZE / EZSQUEEZE TO CLIMB

Ensure:

- a. Each of the two Locking Carabiners / Snaphooks of the SuperSqueeze / EZSqueeze are attached to each side D-ring of your body belt and the gates are completely closed and facing outwards.
- b. The outer Strap of the SuperSqueeze / EZSqueeze is around the pole and the Serrated Rotosnap of the Inner Strap is attached to the eye of the WebGrab.
- c. Hardware components are positioned at the 3:00 and 9:00 position.
- d. While at ground level with the SuperSqueeze / EZSqueeze even with the D-rings of your body belt, the Inner Strap (Rope or Woven Web) is adjusted so you are in an ideal climbing position. This is typically measured by placing your elbow into your stomach with fingers outstretched touching the pole.

6. HOW TO HOLD THE SUPERSQUEEZE / EZSQUEEZE WHEN READY TO CLIMB:

Prior to initiating the climb, and with the SuperSqueeze / EZSqueeze properly adjusted at the 3:00 and 9:00 position, grasp the Outer Strap Handle (SuperSqueeze) / Outer Strap Loop Handle (EZSqueeze) with one hand (Fig. 11a / 11b) and the Serrated Rotosnap in the other (Fig. 12a / 12b). Spread the hardware slightly (1" max) away from the pole and lift the SuperSqueeze / EZSqueeze to chest height. (NOTE: the SuperSqueeze / EZSqueeze must remain snug to the pole) (Fig. 11a, 11b, 12a and 12b).

Fig. 11a



Fig. 11b



Fig. 12a



Fig. 12b



7. HOW TO HITCHHIKE:

- a. To initiate the ascent, set the 1st climber gaff approximately 10" up the pole and the 2nd climber gaff approximately 10" above the first. With the gaffs set, flip the SuperSqueeze / EZSqueeze up to chest height (Fig. 13) using either forearm and elbow motion or shoulder and arm motion.
- b. With the SuperSqueeze / EZSqueeze adjusted around the pole at chest height take a short step or two with climbers to ascend. Then with the gaffs set, again flip the SuperSqueeze up to chest height (Fig. 13). Repeat the described procedure until at the desired height.
- c. To descend, perform steps 7a & 7b above in reverse.

NOTE: The inner strap (Rope or Woven Web) must always be snug around the pole when climbing. Also, shortening the inner strap and by flipping the SuperSqueeze / EZSqueeze shorter distances makes climbing less strenuous. Flipping the strap approximately the same distance that you can bend your elbows may aid in reducing stress on your body.



← Waist

→ Chest

Keep the SuperSqueeze / EZSqueeze between the waist and chest as you hitchhike



Fig. 13

8. ADJUSTING THE SUPERSQUEEZE / EZSQUEEZE TO THE CIRCUMFERENCE OF THE POLE.

- a. Pole circumference changes encountered as you ascend or descend the pole requires Outer Strap length adjustment to keep the hardware in the 3 and 9 o'clock positions.
- b. To shorten, grasp the brown Outer Strap behind the WebGrab and pull towards the back of the pole (away from your body). This will cause the WebGrab to adjust towards the pole shortening the Outer Strap (Fig. 14).
- c. To lengthen:
 - (1) the SuperSqueeze, lean slightly towards the pole taking tension off the strap to relax tension on the WebGrab Cam. Gradually depress the WebGrab Cam towards the pole (Fig. 15a) while slowly leaning back, until you have adjusted it to your desired length.
 - (2) the EZSqueeze, use the palm of your hand to tap the WebGrab BuckHorn away from you and towards the back of the pole (Fig. 15b). This will lengthen the Outer strap approx. a 1/2" with each tap. Continue until you have adjusted it to your desired length. Note: You do not have to take tension off of the EZSqueeze to make this adjustment.
- d. Alternate method to lengthen the EZSqueeze: Relax tension on the WebGrab Cam by leaning slightly towards the pole and take tension off the strap. Hook your thumb on the WebGrab BuckHorn and twist WebGrab frame towards the pole (Fig.15c) while slowly leaning back, until you have adjusted it to your desired length.



Fig. 14

To Shorten



Fig. 15a



Fig. 15b

To Lengthen



Fig. 15c

9. LANYARD OPTIONS FOR CLIMBING OVER OBSTRUCTIONS

When the user ascends or descends the pole and comes to an obstruction, a secondary lanyard is required. Buckingham offers three options:

- i. Option 1 is a Buck-A-Juster adjustable positioning lanyard with a length adjustment device.
- ii. Option 2 is a woven web strap with friction buckle adjustment.
- iii. Option 3 is a Buck Leverjust.

Option 1

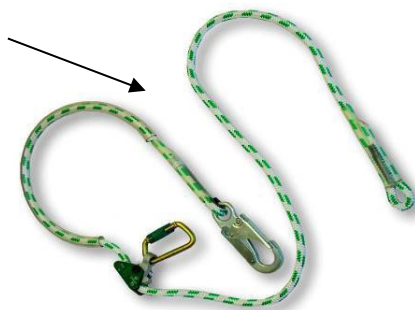

Option 2

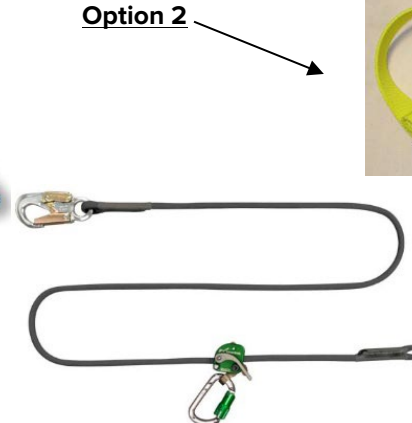

Option 3

(Read carefully, understand and heed all instructions and warnings included with that device before using this equipment).

10. HOW TO CLIMB OVER AN OBSTRUCTION DURING AN ASCENT WITH A SECONDARY LANYARD OR STRAP.

Ensure secondary lanyard device is properly attached to body belt. (Always read carefully, understand and heed all instructions and warnings included with that device before using this equipment). To ease transitioning over obstructions, step up the pole so chest position is approximately at the same height as the top of the obstruction.

- a.) With obstruction at approximately chest height, adjust secondary lanyard to length so that it will pass around the pole, over the obstruction and back to the opposite side body belt D-ring.
- b.) Place the secondary lanyard around the pole, **over** the obstruction and connect the snaphook or carabiner back to the opposite side body belt D-ring. Take a couple of steps up and minimize the fall distance by re-adjusting the length of the secondary lanyard.
- c.) Once the secondary lanyard is secured **over** the obstruction, adjust the WPFRD by compressing the WebGrab Cam and lengthen the Outer Strap to disconnect the Serrated Rotosnap from the WebGrab. Disconnect the Serrated Rotosnap from the WebGrab and place the outer and inner strap of SuperSqueeze / EZSqueeze on top of the secondary lanyard so both hands are free.
- d.) Wrap the outer strap around the back of the pole and over the obstruction, slide the WebGrab from behind or the side of the pole towards your body until it can be clearly seen (Fig. 2a) and to ensure proper attachment of Serrated Rotosnap to the eye of the WebGrab cam.
- e.) Then connect the Serrated Rotosnap to the eye of the WebGrab above both the obstruction and the secondary lanyard. With each connection, visually check that the Serrated Rotosnap engages the WebGrab cam eye and that the keeper / gate is completely closed. Never rely solely on the feel or sound of the Serrated Rotosnap engaging.

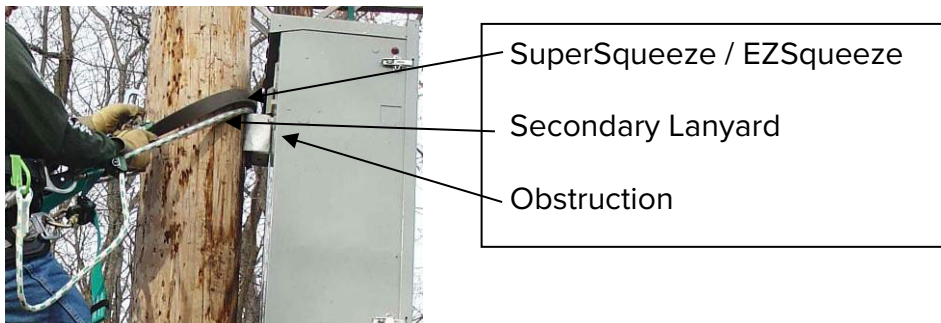

- f.) Adjust the Outer Strap so the hardware locators are at the 3 and 9 o'clock positions ensuring that the Inner Strap is snug to the pole as shown below. (See instruction 3 for more details).



- g.) Once the SuperSqueeze / EZSqueeze is properly secured, lengthen the adjustment of the secondary lanyard transferring your weight back into the SuperSqueeze / EZSqueeze, then disconnect the secondary lanyard above the obstruction and continue the ascent.



11. HOW TO DESCEND PAST AN OBSTRUCTION WITH A SECONDARY LANYARD OR STRAP.

- a.) As the user descends and comes to an obstruction, adjust secondary lanyard to length so that it will pass around the pole, over the obstruction and back to the opposite side body belt D-ring. Then simply secure the secondary lanyard around the pole and **above** the obstruction and **below** the SuperSqueeze / EZSqueeze.
- b.) Connect the secondary lanyard snaphook or carabiner back to the opposite side body belt D-ring.
- c.) Minimize the fall distance by re-adjusting the length of the secondary lanyard.
- d.) With the secondary lanyard secured, compress the SuperSqueeze / EZSqueeze WebGrab Cam to lengthen the Outer Strap of the SuperSqueeze / EZSqueeze to ease removal.
- e.) Disconnect the SuperSqueeze / EZSqueeze Serrated Rotosnap from the WebGrab.
- f.) Wrap the outer strap around the back of the pole and under the obstruction, slide the WebGrab from behind or the side of the pole towards your body until it can be clearly seen (Fig. 2a) and to ensure proper attachment of Serrated Rotosnap to the eye of the WebGrab cam. Then connect the Serrated Rotosnap to the eye of the WebGrab below both the obstruction and the secondary lanyard. With each connection, visually check that the Serrated Rotosnap engages the WebGrab cam eye and that the keeper / gate is completely closed. Never rely solely on the feel or sound of the Serrated Rotosnap engaging.
- g.) Readjust the SuperSqueeze / EZSqueeze so the hardware locators are set at the 3 and 9 o'clock positions and readjust the Inner Strap until snug (See instruction 3 & 4 for more details).
- h.) Lengthen the adjustment of the secondary lanyard transferring your weight back into the SuperSqueeze / EZSqueeze.
- i.) Disconnect the secondary lanyard from above the obstruction and continue the descent.



12. HOW TO PERFORM A HURTMAN RESCUE

(Note: Extreme caution must be taken when practicing or performing hurt man rescue as the rescuer may need to position their SuperSqueeze / EZSqueeze, near the victims. Always visually ensure the strap you are about to cut is that of the victim's unit not yours. Keep your unit as far from the victims as possible.

- a.) Once the victim has been secured using the method described by user's employers safety practice, either the Outer Strap (brown neoprene impregnated nylon) or the Inner Strap (woven web or rope) may be cut to release the victim from the pole.
- b.) Generally, the Inner Strap will have a gap and be easier to cut (See example at right).
- c.) Ensure the victim has been properly secured as outlined by user's employers safety practice prior to cutting either strap.

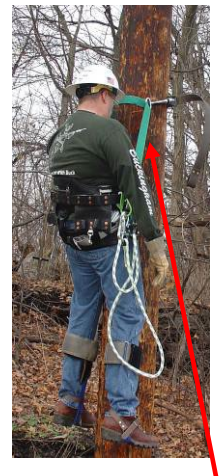

13. INSTRUCTIONS FOR USING THE SUPERSQUEEZE / EZSQUEEZE TO CLIMB WOOD POLES WRAPPED IN BIRD WIRE OR A POLE WITH A SIGNIFICANT AMOUNT OF GAFF SPLINTERS.

- a.) To initiate the climb, grasp approximately 2" of inner woven nylon between your fingertips and the Outer Strap Handle (SuperSqueeze) / Outer Strap Loop Handle (EZSqueeze).
- b.) To climb, spread Outer Strap Handle (SuperSqueeze) / Outer Strap Loop Handle (EZSqueeze) and Serrated Rotosnap just far enough apart to clear the bird wire or splinters and advance the Super Squeeze / EZSqueeze up to approximately chest height which will tighten the inner woven web strap on pole and set SuperSqueeze / EZSqueeze.
- c.) Using your gaffs, take two steps up the pole until the SuperSqueeze / EZSqueeze is approximately even with your waist. Then with your gaffs set firmly in the pole, repeat step b as necessary to complete ascent.

**Example:
Cut Strap Here for
Hurt Man Rescue**

Notes: When SuperSqueeze / EZSqueeze is moving, gaffs must be set. When gaffs are moving SuperSqueeze / EZSqueeze must be set (2" grasp as stated in step one can still be maintained after SuperSqueeze / EZSqueeze is set). Bird wire creates the potential for the Cleat to snag when flipping the outer strap (see step b above).

14. INSTRUCTIONS FOR USING THE SUPERSQUEEZE / EZSQUEEZE TO CLIMB STEEL POLES WITH STEPS.

- The SuperSqueeze / EZSqueeze **can** be used to climb smooth sided steel poles with attached steps **only** when it has been retro fitted with Buckingham Serration Grips (PN 488C2).
- The SuperSqueeze / EZSqueeze with attached Serration Grips **cannot** be used to climb smooth sided steel poles without attached steps.
- The Serration Grips are intended to cover the contact points of the Serrated Rotosnap and the cleat as shown in Fig. 16. (See Buckingham's 488C2 instructions (PN 230306) for the proper attachment of these grips)
- While climbing steel pole steps, the SuperSqueeze / EZSqueeze will need to be adjusted with the minimum slack required to move the SuperSqueeze / EZSqueeze over the pole steps.
- Once over the pole step, take a couple of steps up and minimize the fall distance by re-adjusting the length of the SuperSqueeze / EZSqueeze.
- Repeat this procedure until the desired work position is achieved.



Fig. 16

15. INSTRUCTIONS FOR USING THE SUPERSQUEEZE / EZSQUEEZE WITH A HAND LINE.



Fig. 17



Fig. 18

Under certain circumstances a hand line may come into contact with the gate of the Serrated Rotosnap. Pulling the hand line up under these circumstances (Fig. 17), may cause the gate to rotate and open thus allowing the hand line to transfer inside the Serrated Rotosnap (Fig. 18). Although inconvenient, we do not believe it to be a safety hazard. The hand line can be easily removed and repositioned from the Serrated Rotosnap.

If using a hand line attached directly to the pole while using the SuperSqueeze / EZSqueeze, one of the following actions can be initiated to eliminate the aforementioned potential:

- Position the Serrated Rotosnap opposite the hand line.
- Shift the position of the Serrated Rotosnap forward or backwards (while maintaining proper adjustment).
- Reposition the hand line so it does not come into contact with the gate of the Serrated Rotosnap.

16. INSTRUCTIONS FOR USING THE SUPERSQUEEZE / EZSQUEEZE ON ENGINEERED LAMINATED WOOD POLES (E-LAM POLES).

The SuperSqueeze / EZSqueeze has been tested in accordance to applicable dry pole / wet pole test sections of the ASTM F887-23 and CSA Z259.14-12 standards (type A criteria) using an approximately 8 1/2" x 10 1/2" section and 12 1/4" x 21" section of an E-Lam pole (Fig. 19).

Based on these test results and previous testing we have approved the SuperSqueeze / EZ Squeeze for use on these types of poles only when the unit is placed at waist level or above and used by a worker with a maximum weight of 350 lb. when fully equipped. Additionally, placement of the unit on these types of poles needs to be specific in order for the system to adequately perform. When the SuperSqueeze / EZSqueeze is positioned on the pole with the corner of the pole towards the climber, the backbone of the Serrated Rotosnap must be positioned on the corner of the pole and the Cleat just in front of the opposite corner as shown (Fig. 20).

Note: When climbing with the corner of the pole centered to your chest your gaffs should stagger the corner of the pole as shown (Fig 21).



Fig. 20

Typical Engineered Laminated Wood Pole



Fig. 19

Gaff Placement Zone



Fig. 21

Cleat: - The Cleat is located on the inside of the Outer Strap. This cleat provides enhanced gripping capabilities to the SuperSqueeze / EZSqueeze when being used on poles exhibiting conditions such as wet, slick, conduit covered, iced poles or E-Lam poles. All SuperSqueeze / EZSqueeze are factory equipped with a permanently installed cleat to eliminate the potential for it to loosen. SuperSqueeze Models dated 8/13 and prior used a thread sealant to permanently attach the cleat. Models dated 9/13 through 9/14 used only a peen process to permanently attach the cleat. Models dated 10/14 and forward, use either method to permanently attach the cleat as is defined by the model number. Product with the cleat conforms to ASTM F887-23, CSA Z259.14-12 Type AB (for use on iced poles) and OSHA 1926.502(e). Without cleat, product conforms to ASTM F887-23, CSA Z259.14-12 Type A (not for use on iced poles) and OSHA 1926.502(e). For laminate poles, with cleat, product conforms to ASTM F887-23 and CSA Z259.14-12 Type A criteria only (not for use on iced laminate poles).

17. INSTRUCTIONS FOR USING THE SUPERSQUEEZE / EZSQUEEZE ON WOOD POLES WITH U- SHAPED GUARD / CONDUIT ATTACHED.

The SuperSqueeze / EZSqueeze has been tested in accordance to applicable wet pole with conduit test sections of the ASTM F887-23 and CSA Z259.14-12 standards (type A criteria) using a 3 3/4" maximum U – shaped galvanized steel guard mounted to the pole (as shown in Fig. 22) to simulate pole conditions with both U-shaped guards and conduit attached.

Based on these test results and previous testing we have approved the SuperSqueeze / EZ Squeeze for use on poles with attached 3 1/8" U-shaped guard or conduit only when the unit is placed at waist level or above and used by a worker with a maximum weight of 350 lb. when fully equipped. Additionally, placement of the SuperSqueeze / EZ Squeeze on these types of poles needs to be specific in order for the system to adequately perform.

One approved position is with the U-shaped guard or conduit located directly in front of the end user (Fig. 23). The other approved position is with the U-shaped guard or conduit directly behind the pole (Fig. 24). The U-shaped guard or conduit must be at either the 6 o'clock or 12 o'clock position in relation to the user when the pole is viewed as the face of a clock.

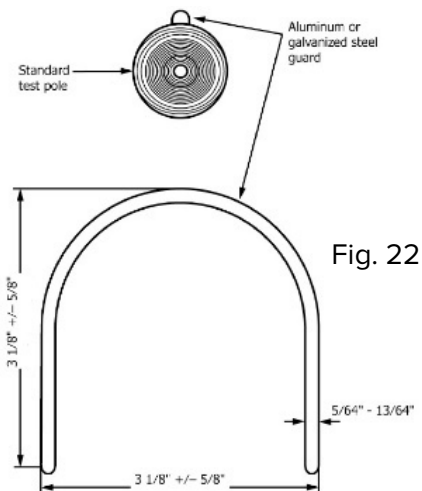

Fig. 23

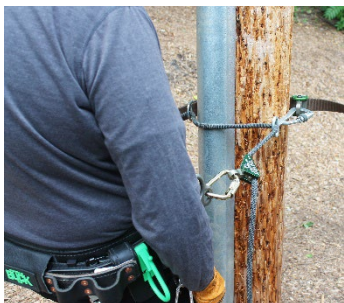

Fig. 24



Fig. 25



Fig. 26

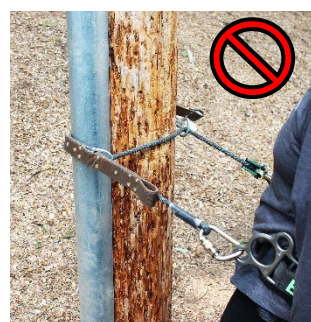

The SuperSqueeze / EZSqueeze hardware (Serrated Rotosnap - Fig. 25 or Cleat Fig. 26) must not be located on or come into contact with U-shaped guards, conduit or any other object that may be mounted to the pole. When the SuperSqueeze / EZSqueeze is mounted over U-shaped guard or conduit ensure that the unit is properly adjusted so that the hardware (Serrated Rotosnap or Cleat) make contact with the pole.

18. INSTRUCTIONS FOR CHANGING THE LOCATION OF OR INSTALLING THE WEBGRAB BUCKHORN .

Notes:

The EZSqueeze series is supplied with a WebGrab BuckHorn installed and facing up when the EZSqueeze is installed on the pole with the WebGrab on your left side as you face the pole. Follow steps (a-h) below to install the WebGrab BuckHorn on the opposite side (top) of the WebGrab when the EZSqueeze is installed on the pole with the WebGrab on your right side as you face the pole.

The SuperSqueeze series is not supplied with a WebGrab BuckHorn. The WebGrab body has threaded retro-fit holes on each side for future retro-fit WebGrab BuckHorn attachment. Follow steps e-h below to attach a WebGrab BuckHorn to either side of the WebGrab body.

- Disconnect the Serrated Rotosnap from the WebGrab cam eye on the outer strap (Fig 27).
- Using a 3/16" hex wrench, remove the 5/16" button head cap screw that secures the WebGrab BuckHorn to the WebGrab body (Fig 28a & 28b). Discard the removed button cap screw.
- Remove the WebGrab BuckHorn (Fig. 29).

- d) Flip entire Outer Strap assembly over so WebGrab is positioned on your right side (Fig 30).
- e) Position the WebGrab BuckHorn onto the WebGrab body as shown (Fig. 31). Note: The center hole in the WebGrab BuckHorn is designed to slip over the WebGrab cam bolt and nut when installed in the WebGrab (Do Not Remove the Cam Bolt or Nut).
- f) Install the new included 5/16" button head cap screw with thread sealant patch through the WebGrab BuckHorn and into the WebGrab body (Fig 32).
- g) Using a 3/16" hex wrench tighten the 5/16" button head cap screw securing the BuckHorn to the WebGrab (Fig 33) (Do Not Over Tighten).
- h) Re-connect the Serrated Rotosnap to the WebGrab cam eye (Fig. 34). The EZSqueeze is now ready for use with the WebGrab on the right side of the pole as you face it (Fig 35).

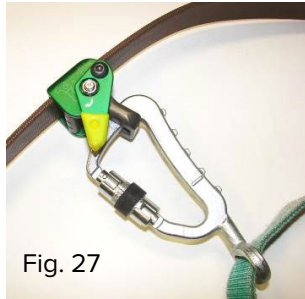

Fig. 27



Fig. 28a



Fig. 28b

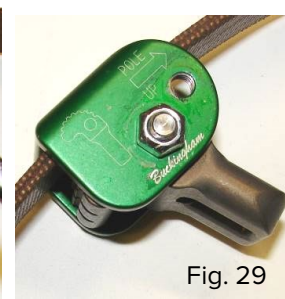

Fig. 29



Fig. 30



Fig. 31



Fig. 32



Fig. 33

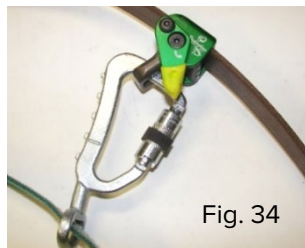

Fig. 34



Fig. 35

WARNINGS:

- ◆ Read carefully, understand, and heed these instructions and warnings before using this equipment. Failure to do so could result in your serious injury or death.
- ◆ This equipment is intended for use by properly trained professionals only.
- ◆ Please consult with your physician prior to using this product. Do not use this product under the influence of drug or alcohol.
- ◆ This product is designed to be used by a person with a maximum weight of 350 lbs. when fully equipped.
- ◆ All Wood Pole Fall Restriction Devices MUST BE properly adjusted and used in accordance with the manufacturer's instructions to function as designed and intended. Proper adjustment of this device according to Buckingham's warnings and instructions is the user's responsibility. Death or serious injury may result to the user in the event that the device is used while out of adjustment.
- ◆ This product is not to be used on smooth sided steel poles without attached steps.
- ◆ If this product is to be used on smooth sided steel poles with attached steps Serration Grips (PN 488C2) must be used. Inspect pole prior to climbing.
- ◆ Ensure that there are no service wires running vertically up the pole. If wires are present install U-guard over the wires or de-energize the circuit prior to installing the SuperSqueeze.
- ◆ Never place or let the SuperSqueeze / EZSqueeze hardware (Serrated Rotosnap or Cleat) come into contact with U-shaped guards, conduit or any other object that may be mounted to the pole that would prevent the hardware from making contact with the wood.
- ◆ Fall protection equipment, (i.e. fall arrest, work positioning, climbers, retrieval, suspension etc.) should not be resold or provided to others for re-use after use by original user as assurance cannot be granted that a used product meets criteria of applicable standards and is safe for use by a subsequent user.

- ◆ Only Buckingham Mfg. Co., or those people authorized in writing by Buckingham Mfg. Co., may make alterations or repairs to this equipment.
- ◆ Inspect your equipment prior to each use. As a minimum, use all inspection instructions included in this document.
- ◆ Do not use this device if the cleat is missing from the outer strap as unit will not function as designed.
- ◆ Selection of products should be such that they aid the worker in the performance of his/her job and particular work situation. Therefore, be certain this equipment is suitable for the intended use and work environment. It should only be used as personal protection equipment (PPE). If suitability for intended use is in doubt, consult your Supervisor, Safety Director, or contact Buckingham Mfg. at (607) 773-2400 or 1-800-937-2825 (8:00 am – 5:00 pm {EST} M-F) before using.
- ◆ Be certain the brown Outer Strap is properly positioned on the pole and the Inner Strap (Woven Web or Rope) is snug to the pole before using. **Failure to heed this warning will result in inadequate gripping capabilities of the unit.**
- ◆ **Never hold the SuperSqueeze or EZSqueeze open while climbing; doing so will result in inadequate gripping capabilities of the unit.**
- ◆ A secondary fall protection device must be used when transitioning above or below an obstruction (i.e. the Outer Strap is disconnected to relocate it above or below an obstruction on the pole).
- ◆ Before use, ensure locking mechanisms of Locking Carabiners / Snaphooks and Serrated Rotosnap are functioning properly. Never disable locking mechanisms, gates, punch holes in, or alter a connecting device or this product in any way.
- ◆ Make sure each Carabiner / Snaphook and Serrated Rotosnap is positioned so that its keeper / gate is never load bearing.
- ◆ With each use, visually check that Carabiners / Snaphooks freely engage the body belt D-rings and that the keeper / gate is completely closed and is facing outward. Never rely solely on the feel or sound of a snaphook or carabiner engaging.
- ◆ With each use, visually check that the Serrated Rotosnap engages the WebGrab eye and that the keeper / gate is closed and facing outward. Never rely solely on the feel or sound of the Serrated Rotosnap engaging.
- ◆ With each use, visually check that the rubber grip attached to the gate of the Serrated Rotosnap is centered in the knurled section. A rubber grip that has slid out of the knurled center section and towards the top or bottom of the gate may prevent the gate from properly closing and locking (Fig. 36a & 36b).
- ◆ When in the work position, ensure there is no pressure on the Snaphook locking mechanism sufficient to depress it as this will, due to its length, render it incompatible with currently designed D-rings and make it very susceptible to rollout.
- ◆ **Never let the WPFRD fall below waist level while ascending, descending, or working. NOTE:** When transitioning above or below obstructions such as cross arms, transformers, cable battery relay boxes, working on a faulty cut out, etc., the WPFRD must be used with a secondary positioning device to prevent the possibility of falling down the pole in the event of a cut-out.
- ◆ **Never allow the D-ring and the Serrated Rotosnap to come into contact with each other.**
- ◆ Ensure all connections are complete and proper before climbing.
- ◆ For personal use only. NOT for towing or hoisting.
- ◆ If a fall or impact loading has occurred the WPFRD should be removed from service and returned to Buckingham Mfg. for inspection or inspected by a trained and qualified, user's company approved inspector.
NOTE: Unit must be taken out of service and replaced if there is any question regarding it being safe for use.
- ◆ All affixed labels should be left in place and all instructional material be kept for future reference.
- ◆ Avoid contact of this equipment with sharp edged or pointed tools, hand saws, chainsaws, hand tools, abrasive surfaces, high temperature surfaces, welding or other heat sources, electrical hazards, chemicals, moving machinery etc.
- ◆ Be aware of this device's position / placement at all times in relation to the operations being performed. Use extreme caution when performing operations such as cutting, drilling, sawing, etc. Always perform this type of work well above this device to avoid the potential of tool contact, causing damage which may result in a fall, serious injury or death).
- ◆ When performing a Hurt Man Rescue, be aware of your device's position / placement in relation to the victims device. Visually ensure the strap you are about to cut is that of the victim's device, not yours.
- ◆ Never work without independent fall protection if there is danger of a fall.
- ◆ Never transfer from a ladder to a wood pole, steel pole or other structure or vice versa.
- ◆ Ensure a rescue plan and resources are in place before climbing.
- ◆ Employer – instruct employee as to proper use and warnings before use of equipment.
- ◆ This Product meets applicable criteria of OSHA 1926.502(e), and ASTM F887 and CSA Z259.14-12 (Type AB) as manufactured (with cleat) and through proper use of the product when used on round poles and Type A criteria when used on non-iced E-Lam poles.
- ◆ Product covered under these instructions / warnings should not be resold, redistributed, or re-used after use by the original user.
- ◆ Consult your doctor if there is reason to doubt your fitness to safely absorb the shock from a fall arrest. Age and fitness seriously affect a worker's ability to withstand falls. Pregnant women or minors must not use any Buckingham Manufacturing equipment.



Fig. 36a



Fig. 36b

- ◆ The pole to be climbed must have a minimum diameter of 5 inches (127 millimeters) or a minimum circumference of 15.75 inches (400 millimeters). This measurement must be taken when the WPFRD is above the user's waist.
- ◆ It is essential for safety of the user that if a product is re-sold outside the original country of destination the reseller shall provide instructions for use, for maintenance, for periodic examination and for repair in the language of the country in which the product is to be sold.

CLEANING: Proper maintenance and storage of your equipment will prolong its useful life and contribute toward its performance. The equipment should be cleaned and maintained at regular intervals depending on usage. Nylon - Clean with water and mild soap (a dish washing soap that removes grease (such as Dawn) and allow to dry thoroughly without using excessive heat. Use Rainbow Cleaner and Degreaser (PN 4305) if the Woven Web becomes excessively dirty / coated with pole preservatives such as creosote / penta. Follow manufacturer's instructions. It may be helpful to gently scrub using a soft brush prior to rinsing. Rainbow products are available at www.rainbowtech.net.

Do not use any type of corrosive substance or acid, which will gradually degrade the fabric. **Note:** Rainbow cleaner is a highly flammable material. Therefore, manufacturer's directions and warnings must be followed. In addition, materials cleaned with this product must be thoroughly rinsed with water and allowed to dry prior to use.

LUBRICATION: Lubricate lock mechanisms, keepers and gates of Carabiners / Snaphooks at least weekly or as often as required to maintain smooth operation (no binding). Lubricate springs on LADs (WebGrab / BuckGrab or LeverGrab™ as often as required to maintain smooth operation. Use a lightweight lubricant such as, WD-40®.

NOTES: Ensure proper fit / size of product before use. This product cannot be returned unless it is in new / unused condition.

Patented, for more information, visit BuckinghamMFG.com/Patents.

Product lines listed above, and instructions meet requirements set forth in European Standard, ENA Number: ENA TS 43-123 Class A1. Examination of ongoing standard conformity carried out by Satra Technology Centre, UK.

SATRA Technology Europe Ltd,
 Bracetown Business Park,
 Clonee,
 Co. Meath
 D15 YN2P
 Ireland

Notified Body Number: C€2777

<p>BUCKINGHAM P.O. Box 1690 Binghamton, NY 13904, USA</p> <p>P/N: J488R2 MFG. DATE: S/N :</p> <p>C€ 2777 Regulation (EU) 2016/425 ENA TS 43-123 Class A1</p> <p>WARNING DO NOT USE THIS PRODUCT WITHOUT READING AND FOLLOWING THE INSTRUCTION / WARNING LITERATURE SUPPLIED. CONTACT BUCKINGHAM MFG. CO. AT 1-800-937-2825. ASSEMBLED IN USA</p> <p><small>LBL06128 102324.fmt</small></p>	 <p>WARNING: Cancer and Reproductive Harm- www.P65Warnings.ca.gov</p>
---	---



NOTE: P/N MFG. DATE and S/N may vary on labels above.

LOCKING SNAPHOOK INSPECTION PROCEDURE

- THOROUGHLY INSPECT EACH SNAPHOOK BEFORE EACH USE TO ENSURE:

- > Rivets have adequate head and are not loose such that function is compromised.
- > Snaphook is not cracked, corroded or distorted, ensure the gate (keeper) does not bind and properly seats in the bill.
- > Keeper is not bent or distorted, ensure it properly seats in the bill.
- > Keeper and lock mechanism are free of burrs.
- > Keeper and lock mechanism and rivet attachment points are properly lubricated.
- > Keeper extends into the bill, 3/16" min. (Fig. 37)
- > Keeper and lock mechanism springs are properly seated and aligned.
- > Roller turns freely and is not distorted.

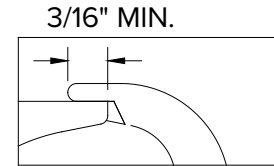

Fig. 37

- LUBRICATE lock mechanism and keeper on both sides AT LEAST WEEKLY or OFTEN AS REQUIRED to maintain smooth operation (no binding) with light weight lubricant such as, WD-40®.

- LOCKING SNAPHOOKS FEATURE A SELF-CLOSING, SELF-LOCKING MECHANISM WHICH REMAINS CLOSED UNTIL UNLOCKED AND PRESSED OPEN FOR CONNECTION OR DISCONNECTION.

- > When the lock mechanism is not activated, the keeper should remain securely locked when depressed.
- > Depress the lock mechanism. It should move downward easily and spring back to its original position without binding or sticking (Fig. 38).

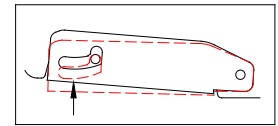

Fig. 38

- > Depress the keeper and lock mechanism simultaneously, (Fig. 39), checking for:
 - >> ease of movement — no binding
 - >> keeper unlocks completely
 - >> keeper opens completely, moves through its full range of motion smoothly, and returns to its original position within the bill.

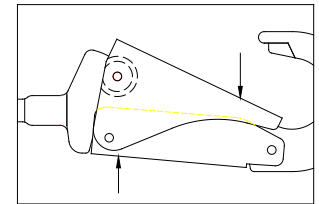

Fig. 39

- > Move the keeper side to side to check for excessive side movement (Fig. 40). Side movement is excessive if the keeper hangs up on the tab of the split bill (Fig. 41)

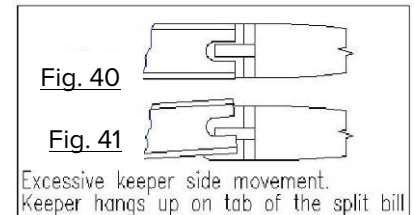

Fig. 40

Fig. 41

Excessive keeper side movement. Keeper hangs up on tab of the split bill

- **NOTE:** MISUSE / ABUSE OF THIS PRODUCT COULD LEAD TO IMPROPER FUNCTIONING WITH RISK OF INJURY!!! NEVER ATTEMPT TO ALTER OR MODIFY A SNAPHOOK TO BYPASS THE LOCK MECHANISM!!!

Hardware shown may vary.

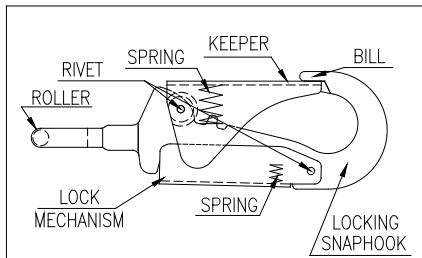

LOCKING POSITIONING STRAP SNAPHOOK

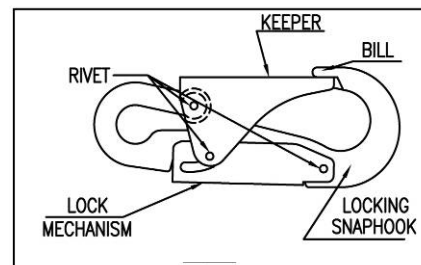

LOCKING SNAPHOOK (LINKLESS CONNECTION)

STATEMENT of OBSOLESCENCE:

Precise “useful life expectancy” or “shelf life” for this product is not specified, as the degree of use, conditions of use, and the degree of care and storage determines useful life. All users maintain responsibility to select proper equipment for the job, be properly trained in its use, and ensure all personnel support equipment passes inspection before each use. Upon evidence of defects, damage or deterioration, all equipment shall be removed from service immediately and tagged or marked as unusable or destroyed. Additionally, all equipment shall be inspected on a regular basis not to exceed one year by a Competent Person, as defined by OSHA/ANSI, to verify that the equipment is safe for use. In the event of any question or concern regarding the condition of such equipment, users shall remove the equipment from service for further inspection. All users must comply with OSHA/ANSI/ASTM and CSA standards prior to and in using such equipment. For more information regarding safe and appropriate use of equipment, please contact Buckingham Manufacturing at 1-800-937-2825.

INTERNATIONAL USERS:

Notwithstanding the above, please know that certain international jurisdictions require manufacturers of equipment to provide customers with a maximum useful lifespan (sometimes referred to as a “Statement of Obsolescence”). To the extent required, Buckingham personal protective equipment manufactured from synthetic fiber materials including but not limited to items such as webbing and/or rope are subject to a maximum useful lifespan of ten (10) years from the date of manufacture. As stated above proper usage, storage, maintenance, and care impacts the useful lifespan of equipment. Extreme circumstances may require that product must be retired after only one use. This statement is made in conformance and compliance with BS EN 365:2004. International users must ensure that product inspections are completed by Competent Persons as defined by international standards including but not limited to British Standard (“BS”). If equipment fails any inspections, it must be immediately withdrawn from service and destroyed. For more information regarding safe and appropriate use of equipment, please contact Buckingham Manufacturing at 1-800-937-2825.

OUR GUARANTEE:

We guarantee the equipment we manufacture to be free from defects in material and workmanship. We will repair any equipment deemed to be defective which is returned to us by the original purchaser. However, this guarantee is void if any product is changed or altered in any way, or if the product is used in a manner other than for which it is intended. This express guarantee supersedes all other expressed or implied guarantees, obligations or liabilities. There are no implied warranties of merchantability or fitness for a particular purpose and as such, all implied warranties are specifically disclaimed.

LIMITATION ON LIABILITY:

In no event will Buckingham or buyer be liable to the other for lost revenues, lost profits or any other indirect, consequential, special or punitive losses or damages, however caused, whether in action for breach of contract, strict liability, tort, or otherwise, even if advised of the possibility of such losses or damages. In no event will Buckingham’s liability exceed the total amount paid by the buyer to Buckingham for the product or equipment giving rise to such claim(s).

Please see other terms and conditions relating to this product at <https://buckinghammfg.com/terms-conditions/>

REGISTRATION:

Before use of the product, ensure to register and confirm the product at www.buckinghammfg.com/register.

BUCKINGHAM MFG.
Binghamton, NY
www.buckinghammfg.com
1-800-937-2825

Information contained in these written instructions supersedes all other information (written, audio, video etc.) produced by Buckingham Mfg. prior to the revision date of this document