

BUCKINGHAM MFG.

OX BLOCK® Instructions and Warnings



Warning: Do not use this product if you cannot understand and follow the instructions and warnings that come with it and complete all necessary functions

OVERVIEW

The Buckingham OX BLOCK is a rope snatch block with an integrated friction bar used for lowering loads, snubbing loads, and raising loads. It allows the rigging professional to handle loads with greater control. When lowering loads, tension is transferred from the worker to the OX BLOCK. The OX BLOCK replaces standard handline blocks, parted blocks, and various snatch blocks. The OX BLOCK also has greater Working Load Limits than blocks of similar size.

ATTACHMENT METHODS

Patented

The Buckingham OX BLOCK is supplied as an independent unit with either a Swivel Eye (PN 50061), a Shackle Top with shoulder bolt and nyloc nut (PN 50062), or a Shackle Top with Buck Pin (PN 50063), and is available with permanently attached slings (Swivel Eye models) or removable slings (Shackle Top models) (See last page of this document for sling / hardware removal and installation instructions). The section below outlines some of the basic configurations to attach the OX BLOCK. All of the configurations shown below can be made with either model. PN 50062AC-Length (Shackle Top model) with attached sling and hook is shown below for reference. The supplied slings have a WLL of 2500 lbs. (11.1 kN) when rigged as shown. Warnings: OX BLOCK with Shackle Top (PN 50062) when supplied as an independent unit (without sling and or hardware) are assembled with the Nyloc Nut being loosely threaded on the Shoulder Bolt. Therefore before use, ensure the Nyloc Nut is completely tightened so that it bottoms out against the shoulder of the bolt.



Choked Configuration:

1. Pass loop end around pole.
2. Then pass block through loop.
3. Pull on tail to tighten sling around pole.
4. Smooth out adjuster.

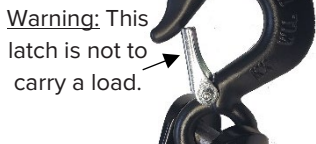
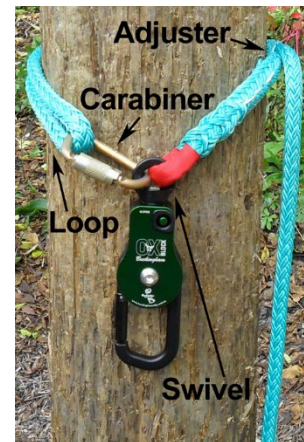

Warning: This latch is not to carry a load.

Double Basket Hitch Configuration:

1. Pass loop end around pole twice.
2. Connect carabiner from OX BLOCK swivel to loop (with gate facing outward).
3. Pull on tail to tighten sling around pole.
4. Smooth out adjuster.



Basket Hitch Over Cross Arm:

1. Pass loop end over cross arm.
2. Connect carabiner from OX BLOCK swivel to loop.
3. Pull on tail to shorten sling and raise OX BLOCK to desired height.
4. Smooth out adjuster.

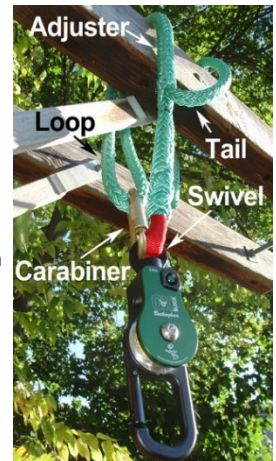



Configurations

Figure 1:
Common

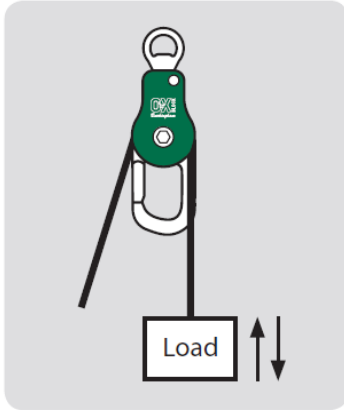

Figure 2:
Lowering Load with Friction

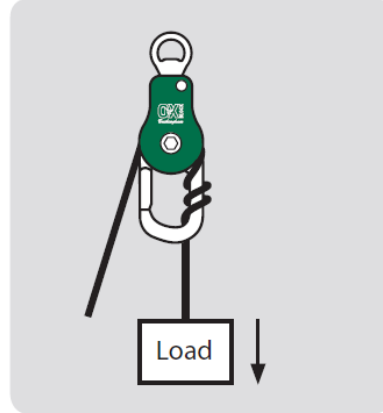

Figure 3:
Snubbing Load

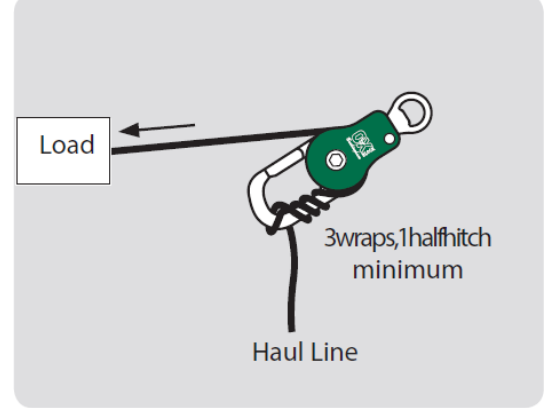
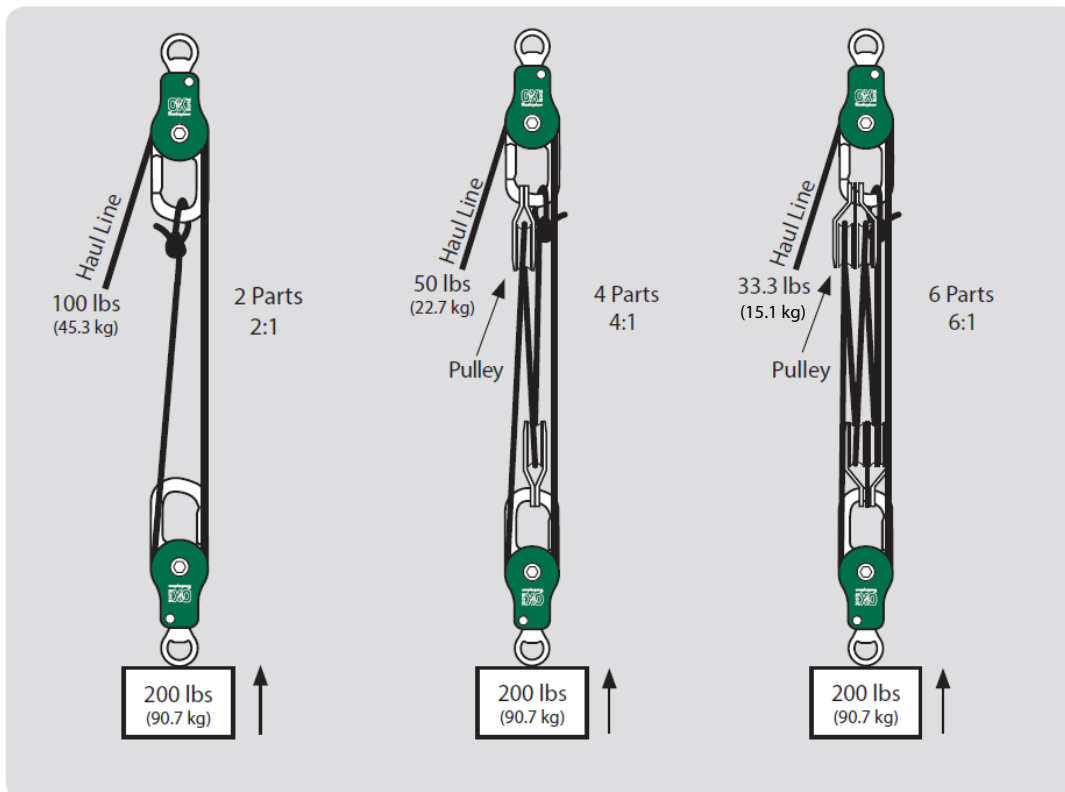

Figure 4:
Raising Load



Warning:
This equipment is intended for use by properly trained professionals only.

WATCH THE VIDEO

www.buckinghammfg.com

Approximate line length required: (lift length x number of pulleys) + 1 lift length

FRICITION ASSISTANCE

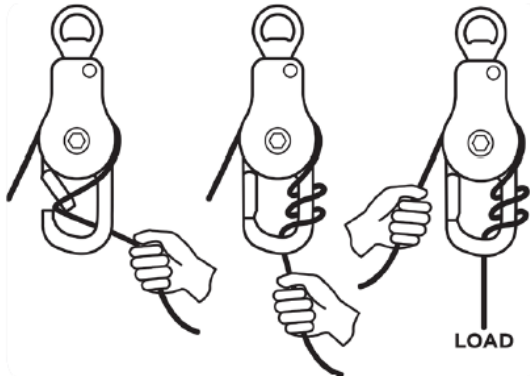

Two times through the gate (2 audible clicks) provides one full wrap.
Three times through the gate (3 audible clicks) provides two wraps.

HAUL-LINE TENSION REDUCTION (WHEN LOWERING LOADS)

On average, one wrap will reduce haul-line tension by a factor of 4:1.

On average, two wraps will reduce haul-line tension by a factor of 10:1.

Cautiously lower the load with extra belay friction to ensure the load can be adequately handled. Weight consideration must be given when lowering loads. i.e. if lowering a 200 lb. (90.7 kg) load with the haul line over only the sheave the user would be holding the entire 200 lb. (90.7 kg) load, if using 1 wrap (4 to 1 ratio) the user is holding 50 lbs. (22.7 kg), using 2 wraps (10 to 1 ratio) the user is holding only 20 lbs (9.1 kg). Heavy loads require additional rope wraps on the friction bar as shown below or may require the use of an additional mechanical advantage.

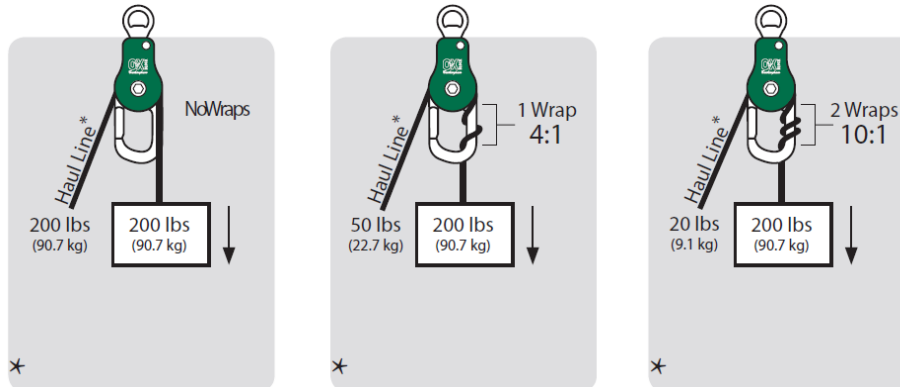

*using 1/2" (12.7mm) Duraplex

FRICITION ASSISTANCE CAN BE USED WITH THE OX BLOCK WHEN:

- the load must be lowered under controlled conditions and/or needs to be periodically stopped during descent.
- the weight ground personnel must hold back needs to be minimized.
- rescuing the injured from heights.
- the load can be transferred to the OX BLOCK without having to first lift the load, or the load can be safely lifted by one person and transferred to the OX BLOCK (for heavier loads that need to be lifted before being lowered, configure two OX BLOCKS into a parted configuration).
- avoiding damage to trees, fences, vehicles (and other items commonly used to reduce friction when lowering loads with ropes) is desired.
- ergonomic benefits are desired for personnel that regularly work with ropes, blocks, and rigged loads.

Warning:
Faceplate must be fully latched, the button engaged and the gate fully closed before applying load.

Friction will vary depending upon on rope material, size and condition. Always test your OX BLOCK rigging in a safe manner to determine hold back force desired and number of wraps you will use on OX BLOCK friction bar.

Haul line tension will vary based on these factors: Diameter of rope, construction of rope, material of rope, clean, dirty, wet or dry rope.

Warning:
For loads that must be lifted before being lowered, friction assistance should not be used unless one person can safely lift the load, or the load must be lifted mechanically first and then lowered using friction assistance of the OX BLOCK.

BUCKINGHAM MFG.

OX BLOCK[®] Instructions and Warnings



PROPER USE

1. Sheave-to-eye and hook-to-eye Working Load Limits must not be exceeded.

SHEAVE-TO-EYE

MBS = 10,000 lbf (44.5 kN)

WLL = 2,500 lbf (11.1 kN)

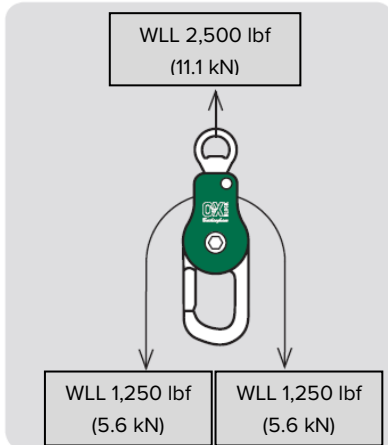

HOOK-TO-EYE

MBS = 6,000 lbf (26.7 kN)

WLL = 1,500 lbf (6.7 kN)

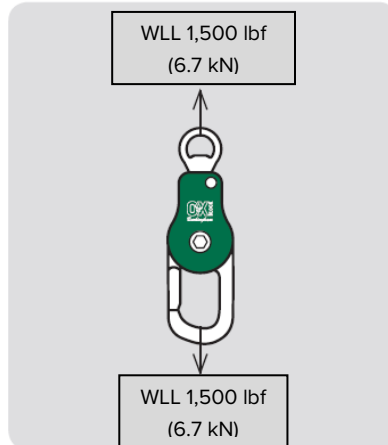

Warning:

Use synthetic ropes only.
Not to be used with wire rope or natural fiber ropes.

Maximum rope diameter is 5/8" (16mm).

Always use adequate anchorage.

2. The OX BLOCK must be free to align with its load, without obstruction of the body or friction bar.

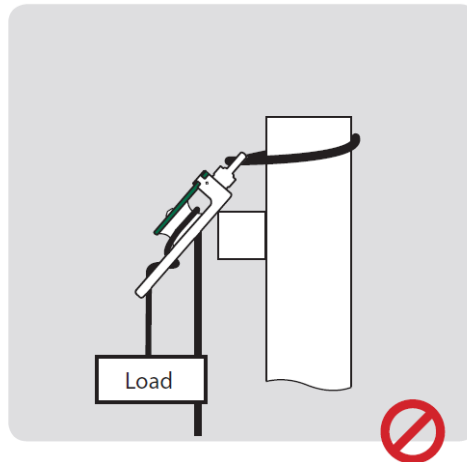
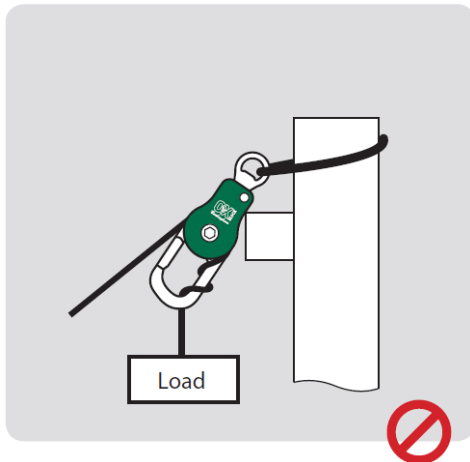

3. The OX BLOCK is designed for multi-braid synthetic ropes (maximum size 5/8" (16mm)) and should not be used with wire ropes or natural fiber ropes.

4. Always ensure the OX BLOCK is attached to an adequate anchorage point that is capable of safely supporting the load and that all rigging components (e.g. carabiners, hardware, pulleys, ropes, slings, etc.) are rated and intended for use with the specific rigging application. In order to get the full WLL from the OX BLOCK (sheave to eye) all components of the system must have a 10,000 lbf (44.5 kN) rating and be configured so as not to reduce that rating. Ropes which have a higher safety factor (generally 5 to 1) must have a 12,500 lbf (55.6 kN) rating to maintain the full WLL (sheave to eye) from the OX BLOCK. The system components should be a minimum of 4 to 1 safety factor for exposure to heavier loads. For example, if lowering 1000 lbf. (4.4 kN) the weakest link must be rated to 4000 lbf. (17.8 kN) minimum breaking strength.

5. Loads being lowered with friction assistance should be lowered under control; never allow running or free falling of a load. Use a hand over hand method to control the rope.

BUCKINGHAM MFG.

OX BLOCK[®] Instructions and Warnings

6. Always close the faceplate before applying any force or load to the OX BLOCK.
7. Always ensure the friction bar safety gate is closed before applying any force or load to the OX BLOCK.
8. Wear to the friction bar is minimized when ropes are clean and descent speed is minimized; loads must never be allowed to run or free fall.
9. Slack must be kept out of the system to prevent high-impact falls.
10. The OX BLOCK is intended for use by medically fit, specifically trained, experienced users.
11. Thorough and specific training is absolutely essential before use. Heights are dangerous. It is up to you to reduce risks as much as possible, but risks can never be completely eliminated. There are many ways to misuse this equipment—too many to list or even imagine. You must personally understand and assume all risks and responsibilities of using this equipment. If you cannot or do not want to do this, do not use this equipment.

INSPECT BEFORE AND AFTER EACH USE

The inspection should include, but not be limited to the following:

- * Check all parts to ensure no corrosion, cracks, deformation, gouges or scratches, rough areas or sharp edges that may abraid the rope or excessive wear exists.
- * That the sideplate rotates normally & the button operates properly.
- * The button is not be impaired by dirt, ice, corrosion, etc.
- * Swivel / shackle top rotates freely and has no excessive vertical movement.
- * The swivel / shackle top bolt is tight and the roll pin used to hold it is in place.
- * Shackle Top models with shoulder bolt (50062): the Nyloc Nut on the hardware attachment Shoulder Bolt is in place and completely tight.
- * Shackle Top models with Buck Pin (50063): Spring mechanism on the Buck Pin is working properly and pin is pushed fully through shackle top to lock pin in place.
- * Ensure smooth rotation of the sheave and proper operation of the gate.

INSPECT DURING USE

Regularly inspect and monitor OX BLOCK while in use, confirming proper connections, position, fully locked faceplates and gate, and fully extended buttons. The OX BLOCK like all equipment must be replaced by the user at regular intervals. This interval should be dictated by the amount of use and type of service the product receives rather than a set time frame. Therefore the manufacturer does not place a time limit on replacement of the OX BLOCK. Due to the rigorous strain the OX BLOCK endures, it should be replaced at the earliest signs of wear. OX BLOCK inspection is extremely important and must as a minimum be performed as stated. If any evidence of wear or deterioration as outlined is observed, immediately cease use, destroy the product, and replace it with new equipment. Should any unusual conditions not outlined above be observed or you have reasonable doubt about a particular condition, remove the equipment from service and notify your Supervisor, Safety Director, or contact Buckingham Mfg. Co. for clarification.

MAINTENANCE & STORAGE

Clean if necessary with fresh water, then allow to dry completely without using excessive heat. The button may be cleaned by holding it upside down & spraying a light lubricant, such as WD-40[®], into it while operating it. Store in a dry place away from extremes of heat and cold, and avoid chemical exposure.

PRINCIPAL MATERIAL

Aluminum alloy, anodized.

REPAIRS OR MODIFICATIONS TO EQUIPMENT

Only Buckingham Mfg. Co. or those people authorized in writing by Buckingham Mfg. Co. may make repairs / modifications to this equipment. Therefore, do not alter, modify or repair this product.

WARNINGS

- This equipment is intended for use by properly trained professionals only.
- Manufacturer's instructions shall be provided to the user of this product. If additional copy is needed, contact Buckingham Mfg. Co.
- Completely read, understand, and follow all instructions, warnings, and guidelines pertaining to this and all associated equipment before use. Failure to do so could result in your serious injury or death.



Warning:
Thorough and specific training is absolutely essential before use.

Always refer to rope manufacturer's instructions and warnings.

BUCKINGHAM MFG.

OX BLOCK[®] Instructions and Warnings



- Employer - instruct your employees as to proper use, warnings and cautions before use of this equipment.
- FOR RESCUE PURPOSES ONLY: This product is designed to be used by a person with a maximum weight of 350 lbs (158.7 kg) when fully equipped. In exceptional cases such as an accompanied descent (i.e. hurt man rescue) this system can be used with a load of up to 600 lbs (272 kg), if the following conditions are met:
 - * The rope used in the rescue system has a 6000 lbf. (26.7 kN) minimum static strength.
 - * The Ox Block shows no signs of excessive wear.
 - * At least 2 wraps of rope around the friction bar of the Ox Block are used if ground personnel are assisting in the controlled descent of the rescuer and the victim.
 - * At least 3 wraps of rope around the friction bar of the Ox Block are used if the rescuer alone is to control his and the victim's descent.
 - * All personnel involved in this type of rescue shall be properly trained in this technique.
 - * No impact loading tolerated.
- Personal protection and rigging equipment, (i.e. fall arrest, work positioning, retrieval, suspension, travel restraint, hoisting etc.) should not be resold or provided to others for re-use after use by original user as assurance can not be granted that a used product meets criteria of applicable standards and is safe for use to a subsequent user.
- All components used with the OX BLOCK (carabiners, pulleys, rope, slings, etc.) shall be authorized Buckingham products. Selection of components / products should be such that they aid the worker in the performance of their job and particular work situation. Therefore, be certain this equipment is suitable for the intended use and work environment. It should only be used for intended uses. If suitability for intended use is questionable, always consult your Supervisor, Safety Director or contact Buckingham Mfg. at (607) 773-2400 or 1-800-937-2825.
- Destroy any and all equipment subjected to impact loading.
- As outlined by OSHA 1926.502 (e)(2) positioning devices shall be secured to an anchorage capable of supporting at least twice the potential impact load of an employee's fall or 3,000 lbf. (13.3 kN), whichever is greater versus fall arrest anchor points which must support a minimum of 5,000 lbf. (22.2 kN) per attached worker and be Independent of worker support.
- Avoid rubbing of unit components against abrasive surfaces and sharp edges.
- Avoid contact of this equipment with high temperature surfaces, welding or other heat sources.
- Use this product only in combination with compatible equipment.
- Use this equipment only for the specific purpose for which it is designed and intended.
- Wearing gloves while using this product is highly recommended.
- Only Buckingham Mfg. Co. or those people authorized in writing by Buckingham Mfg. Co. may make repairs / modifications to this equipment.
- Product covered under these instructions / warnings should not be resold / redistributed or reused after use by original user.
- CARABINER USE: Carabiners are acceptable for overhead lifting only under the following circumstances:
 - * Carabiners (10,000 lbf. [44.5 kN] MBS) supplied by Buckingham must be used.
 - * Carabiners must only be loaded along the major axis near the spine. Never cross load a carabiner.
 - * Carabiners must never be shock loaded. If shock loaded they must be removed from service.
 - * Working load limit must not exceed 25% [4 to 1 safety factor] of the breaking strength on the carabiner.
- Employer - instruct employees as to proper use, warnings and cautions before use of this equipment.

DETAILED INSPECTION

In addition to inspection before, during, and after each use, it is recommended that a detailed inspection by a competent inspector be done at least every 3 months (or more frequently, depending on amount and type of use). Make a copy of these instructions and use one as the permanent inspection record; keep the other with the equipment. It is best to issue new gear to each user so they know its entire history.

Date of Purchase		Date of 1 st Use	User
Date	Condition	Inspector	

BUCKINGHAM MFG. CO., INC.
BINGHAMTON, NY
1-800-937-2825
www.buckinghammfg.com

BUCKINGHAM MFG.

OX BLOCK[®] Instructions and Warnings



SLING / HARDWARE - REMOVAL / INSTALLATION

OX BLOCKs with Shackle Top (PN 50062 series) can be configured to accept various length slings or approved optional hardware (Rigging Hook is shown below). (Fig. 1)

SLING / HARDWARE - REMOVAL (Shoulder Bolt w/ Nyloc Nut)

1. Remove the Nyloc Nut from the Shoulder Bolt using a 3/8" drive ratchet, 9/16" socket and a 1/4" hex wrench or similar device. (Fig. 1)
2. Remove the hardware by pulling the Shoulder Bolt through the connecting eye of the hardware. (Fig. 2)
3. Remove the Shoulder Bolt by pulling it completely through the Shackle Top. (Fig. 3)
4. Retain the Shoulder Bolt for re-use.
5. Discard the Nyloc Nut. (A new Nyloc Nut must be used for each reassembly. The Nyloc Nut is intended to be used one time only. (Never re-use the Nyloc Nut). OX BLOCKs with Shackle Top (PN 50062 series) are supplied with one extra Nyloc Nut. (Additional replacement nuts are available from Buckingham by calling 1-800-937-2825).

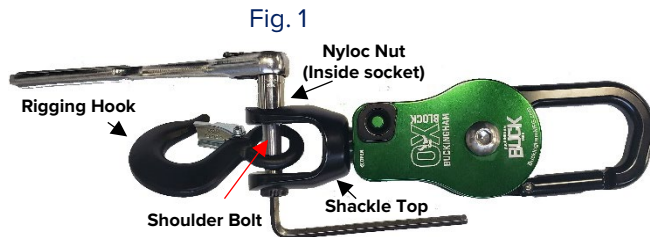

SLING / HARDWARE - INSTALLATION (Shoulder Bolt w/ Nyloc Nut)

1. Obtain a new Nyloc Nut.
2. Insert the Shoulder Bolt through either hole in the Shackle Top.
3. Place any Buckingham approved optional hardware between the sides of the Shackle Top and insert the Shoulder Bolt through the connecting eye of the hardware and through the second hole of the Shackle Top. (Fig. 4)
4. Thread on the Nyloc Nut and securely tighten it using a 3/8" drive ratchet, 9/16" socket and a 1/4" hex wrench or similar.
5. The Nyloc Nut must be completely tightened so that it bottoms out against the shoulder of the bolt. (Fig. 5)

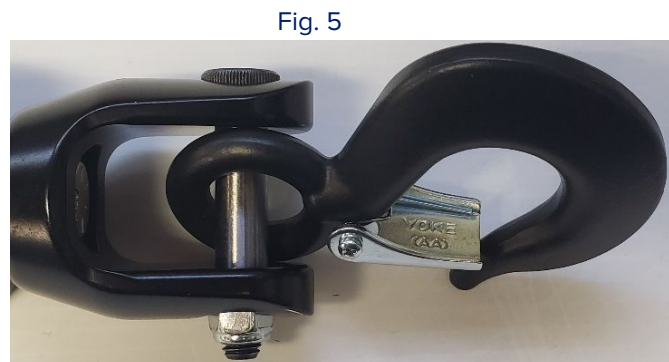

BUCKINGHAM MFG.

OX BLOCK[®] Instructions and Warnings



SLING / HARDWARE - REMOVAL / INSTALLATION

OX BLOCKs with Shackle Top and Buck Pin (PN 50063 series) can be configured to accept various length slings or approved optional hardware (Rigging Hook is shown below). (Fig. 6)

SLING / HARDWARE - REMOVAL (Buck Pin)

1. Using a flat head screwdriver or similar device, disengage the locking mechanism on the Buck Pin. Press the locking mechanism back into the body of the Buck Pin and push the Buck Pin Body towards the head, and out of the Shackle eye simultaneously. (Fig. 7)
2. Repeat step 1 to disengage the Buck Pin from the second eye of the shackle top. (Fig. 8)

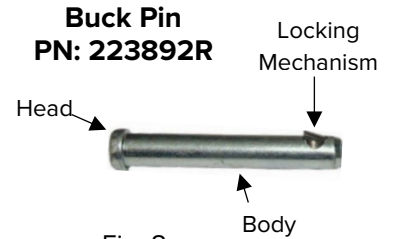

Fig. 6



Fig. 7



Fig. 8



SLING / HARDWARE - INSTALLATION (Buck Pin)

1. Using a Buck Pin.
2. Check that the Buck Pin locking mechanism is lubricated and working properly.
3. Insert the Buck Pin through either hole in the Shackle Top.
4. Place any Buckingham approved sling or optional hardware between the sides of the Shackle Top and insert the Buck Pin through the connecting eye of the hardware and through the second hole of the Shackle Top as shown below. (Fig. 9)
5. Ensure the Buck Pin has been inserted into the Shackle Top far enough for the locking mechanism to activate.
6. Verify that the locking mechanism has engaged by trying to push the pin back through the shackle top prior to each use. (Fig. 10)

Fig. 9



Fig. 10

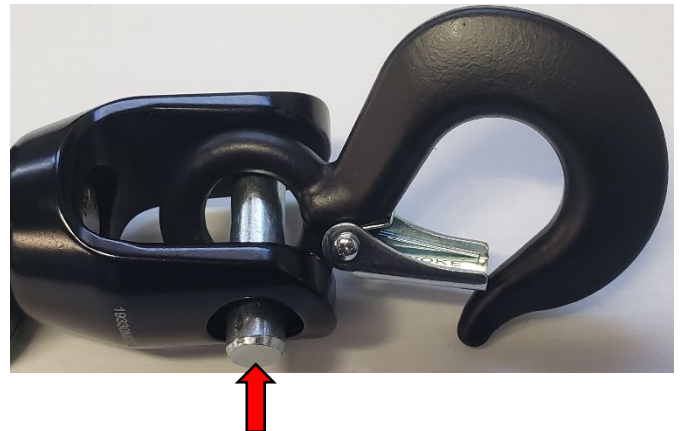

Note: Hardware / Color may vary.

Patented

For more information, visit BuckinghamMfg.com/Patents.

BUCKINGHAM MFG.

P.O. Box 1690
Binghamton, NY 13904
1-800-937-2825

STATEMENT of OBSOLESCENCE:

Precise “useful life expectancy” or “shelf life” for this product is not specified, as the degree of use, conditions of use, and the degree of care and storage determines useful life. All users maintain responsibility to select proper equipment for the job, be properly trained in its use, and ensure all personnel support equipment passes inspection before each use. Upon evidence of defects, damage or deterioration, all equipment shall be removed from service immediately and tagged or marked as unusable or destroyed. Additionally, all equipment shall be inspected on a regular basis not to exceed one year by a Competent Person, as defined by OSHA/ANSI, to verify that the equipment is safe for use. In the event of any question or concern regarding the condition of such equipment, users shall remove the equipment from service for further inspection. All users must comply with OSHA/ANSI/ASTM standards prior to and in using such equipment. For more information regarding safe and appropriate use of equipment, please contact Buckingham Manufacturing at 1-800-937-2825.

INTERNATIONAL USERS:

Notwithstanding the above, please know that certain international jurisdictions require manufacturers of equipment to provide customers with a maximum useful lifespan (sometimes referred to as a “Statement of Obsolescence”). To the extent required, Buckingham personal protective equipment manufactured from synthetic fiber materials including but not limited to items such as webbing and/or rope are subject to a maximum useful lifespan of ten (10) years from the date of manufacture. As stated above proper usage, storage, maintenance, and care impacts the useful lifespan of equipment. Extreme circumstances may require that product must be retired after only one use. This statement is made in conformance and compliance with BS EN 365:2004. International users must ensure that product inspections are completed by Competent Persons as defined by international standards including but not limited to British Standard (“BS”). If equipment fails any inspections, it must be immediately withdrawn from service and destroyed. For more information regarding safe and appropriate use of equipment, please contact Buckingham Manufacturing at 1-800-937-2825.

OUR GUARANTEE:

We guarantee the equipment we manufacture to be free from defects in material and workmanship. We will repair any equipment deemed to be defective which is returned to us by the original purchaser. However, this guarantee is void if any product is changed or altered in any way, or if the product is used in a manner other than for which it is intended. This express guarantee supersedes all other expressed or implied guarantees, obligations or liabilities. THERE ARE NO IMPLIED WARRANTIES OF MERCHANTABILITY OR FITNESS FOR A PARTICULAR PURPOSE AND AS SUCH, ALL IMPLIED WARRANTIES ARE SPECIFICALLY DISCLAIMED.

LIMITATION ON LIABILITY:

IN NO EVENT WILL BUCKINGHAM OR BUYER BE LIABLE TO THE OTHER FOR LOST REVENUES, LOST PROFITS OR ANY OTHER INDIRECT, CONSEQUENTIAL, SPECIAL OR PUNITIVE LOSSES OR DAMAGES, HOWEVER CAUSED, WHETHER IN ACTION FOR BREACH OF CONTRACT, STRICT LIABILITY, TORT, OR OTHERWISE, EVEN IF ADVISED OF THE POSSIBILITY OF SUCH LOSSES OR DAMAGES. IN NO EVENT WILL BUCKINGHAM'S LIABILITY EXCEED THE TOTAL AMOUNT PAID BY BUYER TO BUCKINGHAM FOR THE PRODUCT OR EQUIPMENT GIVING RISE TO SUCH CLAIM(S).

PLEASE SEE OTHER TERMS AND CONDITIONS RELATING TO THIS PRODUCT AT <https://buckinghammfg.com/terms-conditions/>

REGISTRATION:

Before use of the product, ensure to register and confirm the product at www.buckinghammfg.com/register.

BUCKINGHAM MFG.

P.O. Box 1690
Binghamton, NY 13904
1-800-937-2825