

# BUCKINGHAM MFG.

## Installation Instructions / Warnings Buck LeverGrab™ Length Adjusting Device (LAD)

The **PN 5004BM8 Buck LeverGrab™** LAD is designed to add or take up slack in an Adjustable Positioning Lanyard resulting in the system accommodating various circumferences and complementing 1/2" (12.7mm) Kernmantle rope, 15/32" (11.65 mm) Treblekern rope and 1/2" (12.7mm) XTC rope. (Fully assembled Buck LeverGrab™ shown in Fig.1 & Fig. 2).

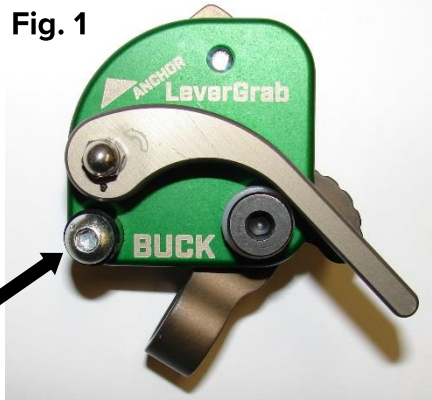

1/4 - 20 x 1 1/4"  
Button Head  
Cap Screw

Front view (front plate is green)



1/4 - 20 x 1"  
Button Head  
Cap Screw

Back view (back plate is black)

**Note:** Before proceeding with this component installation / replacement, inspection of the Adjustable Positioning Lanyard by at least the user must be completed to ensure it is in a condition acceptable for continued use. If any evidence of wear, deterioration or impact loading is observed, immediately cease use, destroy the product and replace it with new equipment. Should any unusual condition be observed, or you have reasonable doubt about a particular condition, remove the equipment from service and notify your supervisor, safety director or contact Buckingham Mfg. at 1-800-937-2825 for clarification.

### Tools Required:

- One 5/32" Allen Wrench
- Loctite® 242 Blue Threadlocker (Included)

### Installation Instructions:

1. Using a 5/32" Allen wrench remove the Silver 1/4 - 20 x 1 1/4" Button Head Cap Screw located on the lower left corner of front plate and the Silver 1/4 - 20 x 1" Button Head Cap Screw located on the top center of the back plate (Fig. 1 - 3).
2. Rotate the front plate to the open position (Fig. 4).
3. Insert the lanyard into the rope channel between the two cams by following the "Rope Path" arrow located on the inside of the back plate (Fig. 5 - 6).

The snap end of the lanyard must be on the same side as the point of the arrow located on the inside of the back plate (Fig. 5 - 6).

Note: The lanyard wear guard needs to be positioned between the snap end of the lanyard and the Buck LeverGrab™ (Fig. 16).



Fig. 3

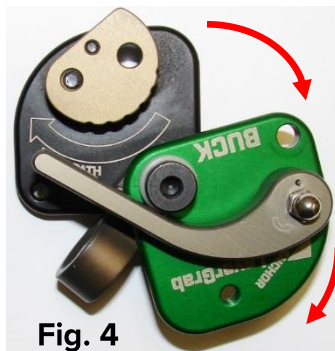

Fig. 4

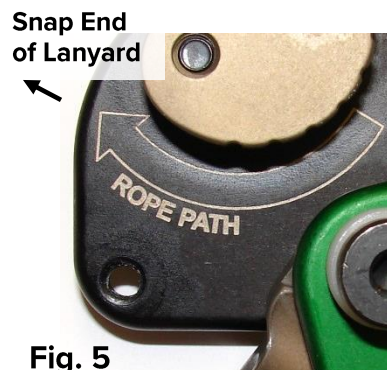

Fig. 5

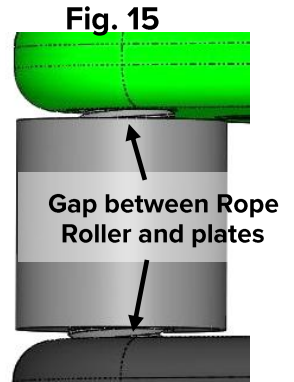
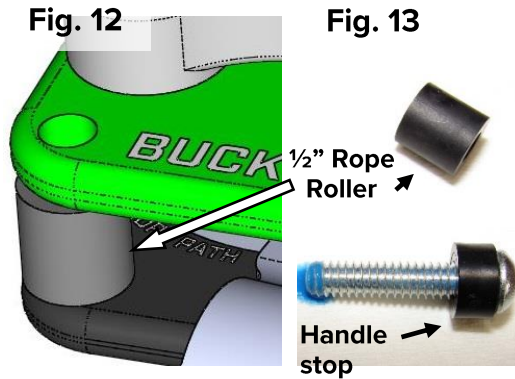
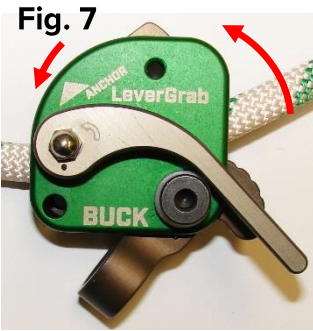

Fig. 6

4. Close the front plate of the Buck LeverGrab™, capturing lanyard inside (Fig. 7).
5. Flip Buck LeverGrab™, over so the back plate is facing up (Fig. 8).

6. Apply one drop of Blue Loctite to the tip of the Silver ¼ - 20 x 1" Button Head Cap Screw (Fig. 9) and insert into the top center hole of the back plate. Use the 5/32" Allen wrench to securely tighten the screw (Fig. 10).
7. Flip Buck LeverGrab™ over so front plate is facing up (Fig. 11).
8. Insert the ½" black nylon rope roller between the front and back plates and align the holes (Fig. 12).
9. Slide the handle stop back onto the ¼ - 20 x 1 ¼" Button Head Cap Screw if it was removed during disassembly.
10. Apply one drop of Blue Loctite to the tip of the Silver ¼ - 20 x 1 ¼" Button Head Cap Screw (Fig. 13) and insert it through the hole in the front plate, the ½" rope roller and begin to thread into the back plate. Then using a 5/32" Allen wrench tighten the screw until snug (Fig. 14). Do Not over tighten.

Notes: There needs to be a space between the rope roller and the plates to allow the rope roller to spin freely (Fig. 15). Use a clean cloth to wipe away any excess Loctite that may have come in contact with the ½" rope roller. The assembled Buck LeverJust™ (Adjustable Positioning Lanyard) should appear as shown (Fig. 16).



### Assembled Buck LeverJust™ Lanyard

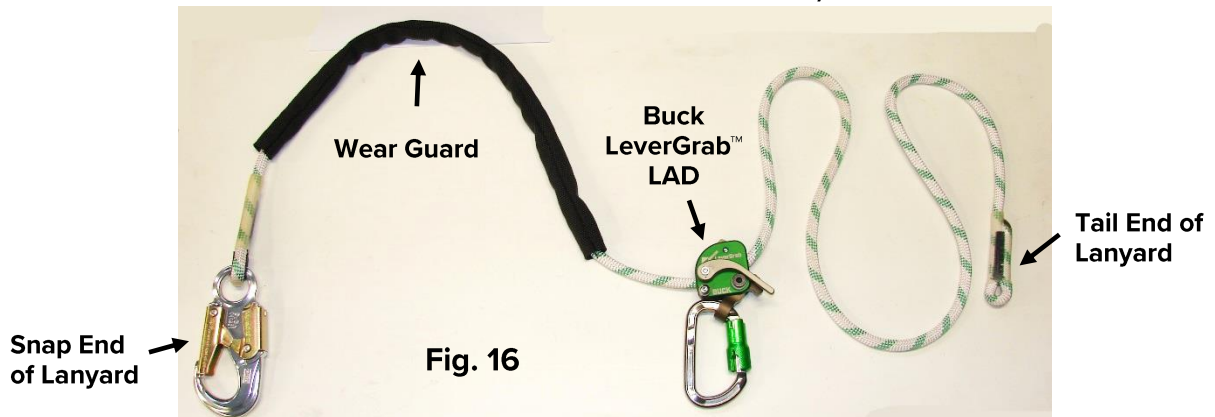

It is imperative that you perform a trial test while standing on the ground to ensure the Buck LeverGrab™ LAD properly grips the rope / locks prior to climbing.

## Buck LeverGrab™ Inspection:

Inspection should include but not be limited to ensuring:

- Unit is free of cracks – (usually depicted by fine jagged lines) and extensive wear or corrosion to cam, or housing.
- Lanyard is properly installed into Buck LeverGrab™, snap end of lanyard exits the Buck LeverGrab™ with the anchor arrow facing the snap end (Fig. 17).
- Proper operation of mechanism by pivoting release lever back and forth. Movement must be unrestricted with no binding. Binding could be caused by burrs, packed snow, or ice.
- All bolts, nuts and screw are properly in place and tightened.

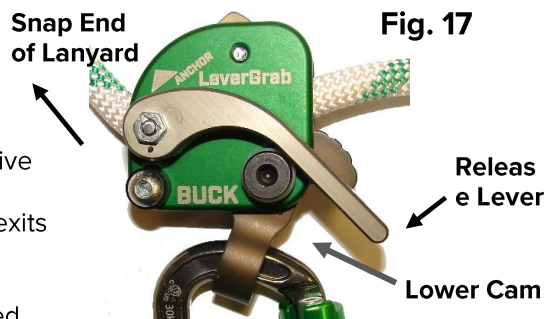

If any evidence of wear or deterioration as outlined above is observed, immediately cease use, destroy the product, and replace it with new equipment. Should any unusual conditions not outlined above be observed, or you have reasonable doubt about a particular condition, remove the equipment from service and notify your Supervisor, Safety Director, or contact Buckingham Mfg. Co. for clarification. Failure to carefully and completely inspect your equipment could result in serious injury or death.

## Warnings:

- Know the job and the regulations governing performance requirements and select the proper equipment.
- Read carefully, understand, and heed these and all other included instructions, warnings, and cautions before using this equipment. Failure to do so could result in your serious injury or death. Should questions arise concerning the proper use or condition of your equipment, contact Buckingham Manufacturing Co. at 1-800-937-2825.
- All affixed labels / markings should be left in place / unaltered and all instructional material kept for future reference.
- This equipment is intended for use by properly trained professionals only.
- This product is designed to be used by a person with a maximum weight of 350 lbs. when fully equipped.
- For personal use only. NDT for towing or hoisting.
- Fall protection equipment, (i.e. fall arrest, work positioning belts, climbers, retrieval, suspension etc.) should not be resold or provided to others for re-use after use by original user as assurance cannot be granted that a used product meets criteria of applicable standards and is safe for use to a subsequent user.
- Be certain this equipment is suitable for the intended use and work environment. It should only be used as personal protection equipment (PPE). If suitability for intended use is in doubt, consult a safety engineer or contact Buckingham Mfg. before using.
- Destroy any and all equipment subjected to impact loading.
- Always attach each snap hook / carabiner of the Adjustable Positioning Lanyard to the proper D-ring of the body belt.
- Do not attach work positioning snap hooks / carabiner to accessory rings. Accessory rings are intended for attachment of a belt supporter only. Note: Belt supporters are intended to distribute belt weight of users who carry an unusually heavy load of tools. Belt supporters are not intended to support the weight of the user.
- As outlined by OSHA 1926.502 (e)(2) positioning devices shall be secured to an anchorage capable of supporting at least twice the potential impact load of an employee's fall or 3,000 lbf. (13.3 kN), whichever is greater.
- Product is manufactured to meet the following standards / regulations as they are applicable: ASTM F887 / OSHA 1926.959 / CA. OSHA 2940.6.
- The Adjustable Positioning Lanyard is only one component / element of a positioning system outlined by ASTM F887.
- Avoid contact of this equipment with sharp edged or pointed tools, high temperature surfaces, welding or other heat sources. (Be aware of the lanyards position / placement on the pole or tree at all times in relation to the operations being performed. Use extreme caution when performing operations such as cutting, drilling, sawing, etc. Always perform this type of work well above the lanyard to avoid the potential of tool contact with the lanyard, causing damage which may result in a fall, serious injury or death).
- Guard against debris which could block the action of the cam (pebbles, twigs, ice, snow, etc.).
- If ice or snow buildup is noted, run the adjusting device along the length of the rope to remove the build-up and ensure the adjusting device is clean and free of packed snow or ice.
- Only Buckingham Mfg. Co., or those authorized in writing by Buckingham Mfg. Co., may make repairs to this equipment.
- Remove from service if subjected to impact loading. Even though no visible signs are present, internal damage may have occurred thus reducing its strength and margin of safety.
- This product is intended for work positioning only.
- Buck LeverGrab™ must not be used on steel cable or wire rope.
- Holding the Release Lever of the Buck LeverGrab™ in the open position, will result in the rope to continue to feed through the unit. Therefore, in the event of a cutout, the Buck LeverGrab™ release Lever must be released for rope to stop feeding through Buck LeverGrab™.
- Never wrap an Adjustable Positioning Lanyard around a sharp member as the material could be cut or damaged.

- The optional wear guard is intended for use on poles, trees, and other structures to minimize wear (i.e. abrasion, cuts, etc.) to the rope. Ensure the wear guard is adjusted properly to cover all contact points of pole, tree, or structure.
- With each use, visually check that the Adjustable Positioning Lanyard snap hook / carabiner freely engages each body belt positioning D-ring and that the keeper / gate is completely closed and facing outward. Never rely solely on the feel or sound of a snap hook / carabiner engaging.
- Ensure each snap hook / carabiner is positioned so that its keeper / gate is never load bearing.
- When in the work position, ensure there is no pressure on the snap hook locking mechanism sufficient to depress it, as this will due to its length, render it incompatible with currently designed D-rings and make it very susceptible to rollout.
- Lubricate lock mechanism and keeper / gate on both sides of snap hook / carabiner at least weekly or as often as required to maintain smooth operation (no binding) with light weight lubricant such as WD-40®.
- Product covered under these instructions / warnings should not be resold / redistributed or re-used after use by original user.

**Adjustable Positioning Lanyard Attachment:** (options & hardware may vary from product shown below)

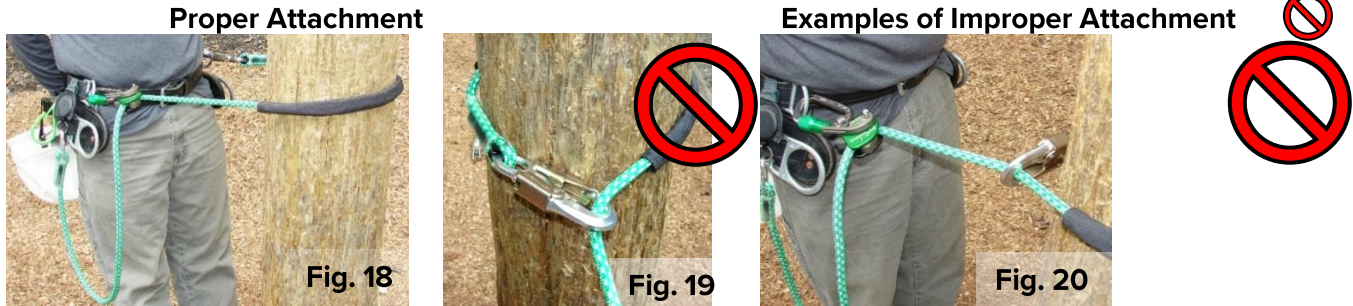

Proper Attachment: connecting hardware of APL must be attached to work positioning D-rings of your body belt as shown in Fig. 18. Gates of the carabiner and locking snaphook must be facing out.

Examples of Improper Attachment: Do not connect Adjustable Positioning Lanyard back onto itself and use as a cinch or choking device (Fig. 19). Do not connect lanyard to a single work positioning D-ring (Fig. 20)

**To Operate:**

1. Ensure Adjustable Positioning Lanyard is properly attached by holding onto the pole and leaning back slowly into the unit. Unit should support user.
2. To shorten the Adjustable Positioning Lanyard, lean slightly towards the pole, tree, or other structure while pulling the free end of the rope through the Buck LeverGrab™. (Fig. 21).
3. To lengthen the Adjustable Positioning Lanyard, slowly rotate the release lever towards your body until the rope feeds through the Buck LeverGrab™, lengthening the lanyard, release lever to stop at your desired position (Fig. 22). Use caution when lengthening device as the Buck LeverGrab™ will not stop until the lever is released or you reach the sewn termination at the end of the lanyard. Alternate method to lengthen Adjustable Positioning Lanyard: lean slightly towards the pole, tree, or other structure, grasp housing of Buck LeverGrab™ and rotate entire device towards your body as you rotate your hip backwards lengthening the lanyard (Fig. 23).
4. While using the Adjustable Positioning Lanyard, adjust length to minimize fall distance to under two feet (2').



**Cleaning / Storage Instructions:**

A dirty product should be washed and rinsed in clean water, then dried. Do not store near solvents, corrosive chemicals or at extreme temperatures. Inspect your equipment carefully before use. This product should be stored in a clean and dry environment out of direct sunlight and away from extreme climate conditions. Ropes should be stored on racks or hooks to provide ventilation and should never be stored on concrete or dirt surfaces.

Patented, for more information, visit [BuckinghamMFG.com/Patents](http://BuckinghamMFG.com/Patents).

**BUCKINGHAM MFG. CO.**

1-800-937-2825

E-mail – [sales@buckinghammfg.com](mailto:sales@buckinghammfg.com)

Web site – [www.buckinghammfg.com](http://www.buckinghammfg.com)

Information contained in these written instructions supersedes all other information (written, audio, video etc.) produced by Buckingham Mfg. prior to the revision date of this document.