

BUCKINGHAM MFG.

INSTRUCTIONS / WARNINGS

PN 4509D - Insert divider for Buckingham 4509 Tool Tray- Assembly

Warning: Do not use this product if you cannot understand and follow the instructions and warnings that come with it and complete all necessary functions.

Buckingham's PN 4509D (Fig. 1) Divider has been designed to organize and securely hold your tools inside of the PN 4509 Tool Tray (Fig. 2). The Divider is supplied fully assembled and held together for shipping with zip ties.

To place the Divider into the Tool Tray:

- Carefully cut the zip ties and remove.
- Hold the Divider by the front and back sides so that it stays assembled.
- Slightly squeeze inward on the front and back sides and carefully lower it into the tool tray (Fig. 3).
- The completed assembly should appear as shown in Fig. 4.

PN 4509 Tool Trays manufactured prior to 11/20 were made with varying inside width dimensions and the Divider may not fit certain models as intended. You can check by measurement to determine if the Divider will fit your tool tray. Some Tool Trays manufactured before 11/20 may measure 7" in width at the bottom of the tray and the divider will not properly fit. Others will measure 7 1/2" and the Divider will fit as intended. All PN 4509 Tool Trays manufactured after 11/20 will measure 7 1/2" at the bottom of the tray allowing the Divider to fit as intended.



Fig. 1 - PN 4509D zip tied for shipping



Fig. 2 - PN 4509 Tool Tray without insert

Fig. 3 - Squeeze front and back of insert

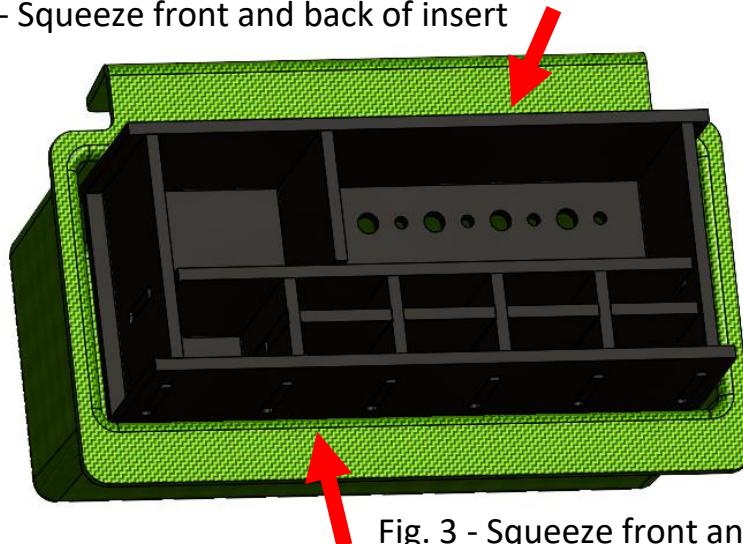

Fig. 3 - Squeeze front and back of insert

The instructions listed below are intended for use in case the Divider becomes disassembled and needs to be re-assembled so it can be placed into the Tool Tray.

1. Start by laying the back panel down. It has 6 vertical slots, and 2 long horizontal slots. Make sure the more widely spaced pair of vertical slots is on the right side.



2. There are 4 small divider pieces. Set them in the middle 4 slots of the back panel with the half slots facing toward you.

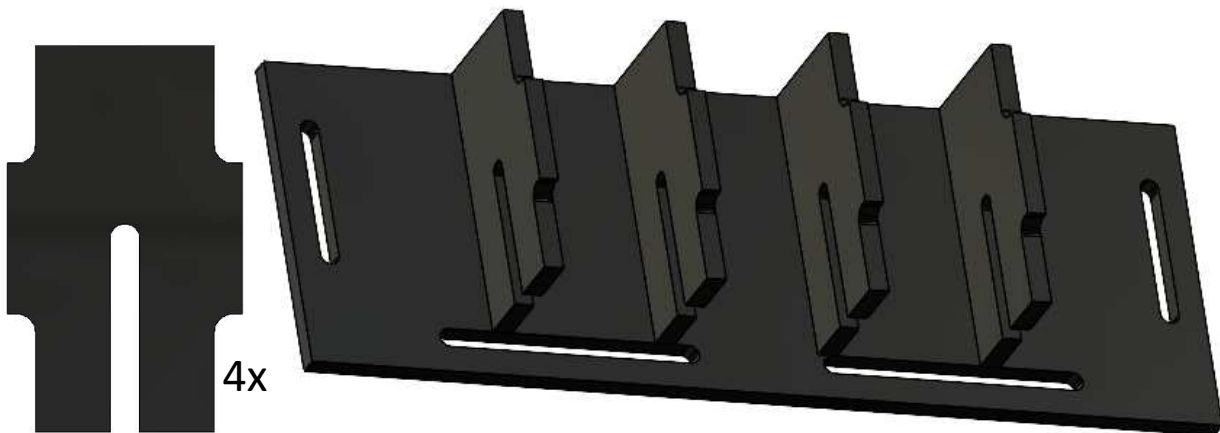

3. Find the piece with 3 half slots:



4. Slide that divider so the half slots join with the half slots of the small pieces from step 2. Make sure it sticks over on the left side, not the right side.

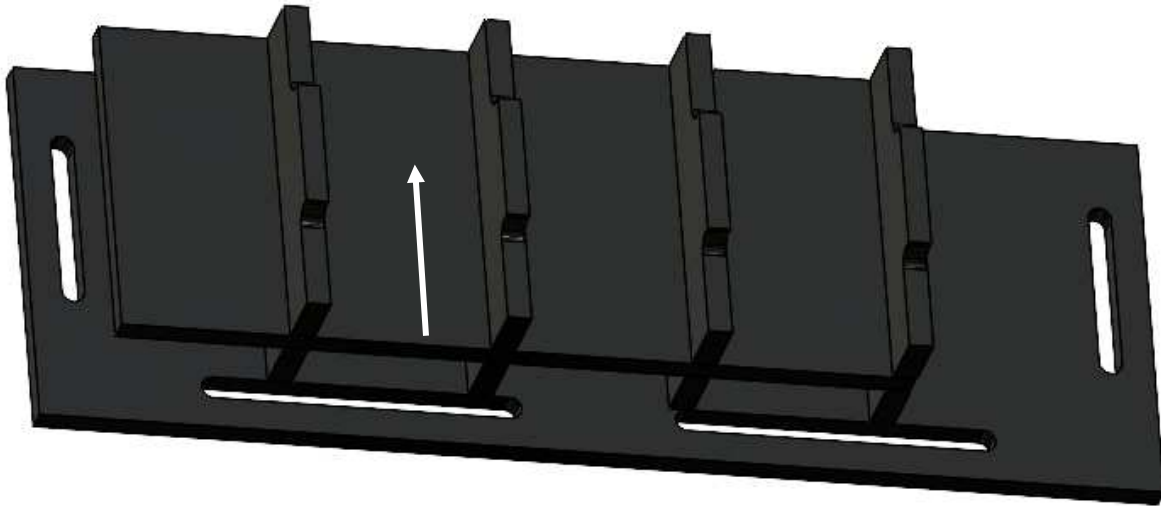

5. Find the piece with 4 vertical slots and a tab sticking out of each end. Hold it so that the end with 3 slots is on the right.

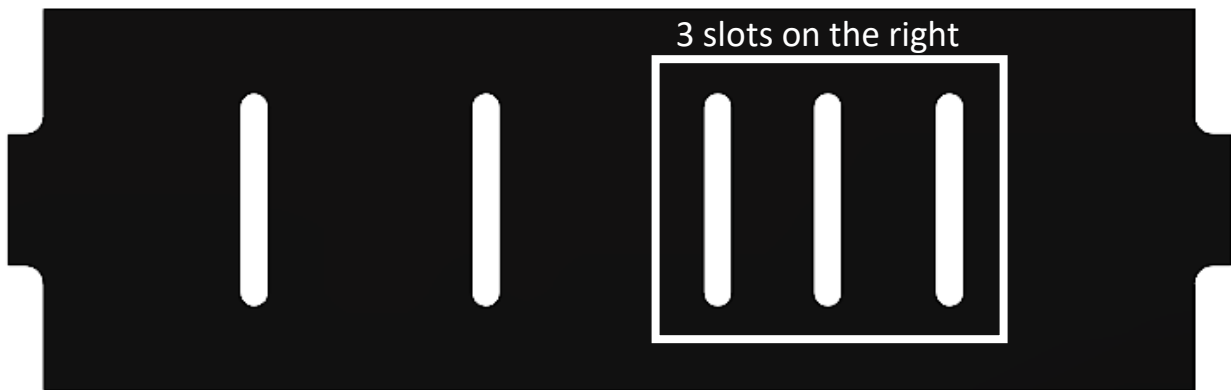

6. Set the piece so that the tabs of the 4 small pieces slide into the slots as shown.

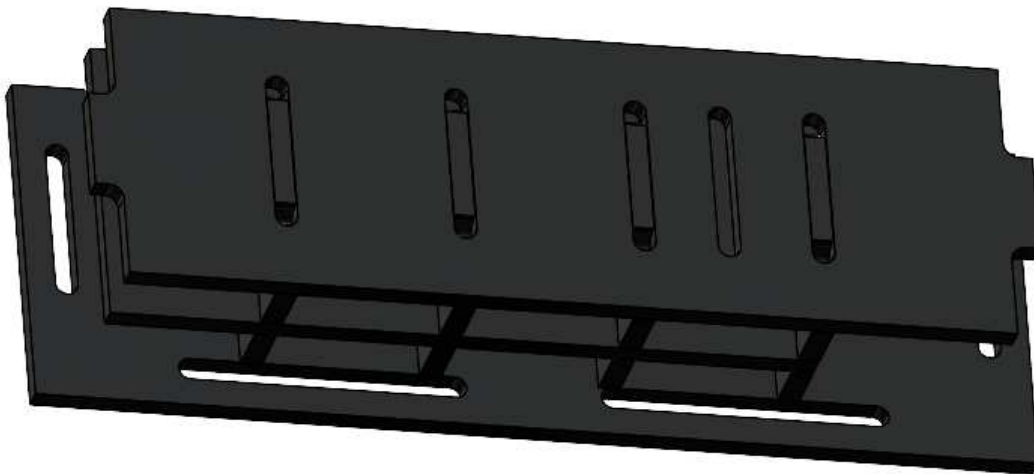

7. Find the two side panels.



8. Put one side panel on the left side by lifting the previous piece slightly so that both the tab and the slot can be lined up.

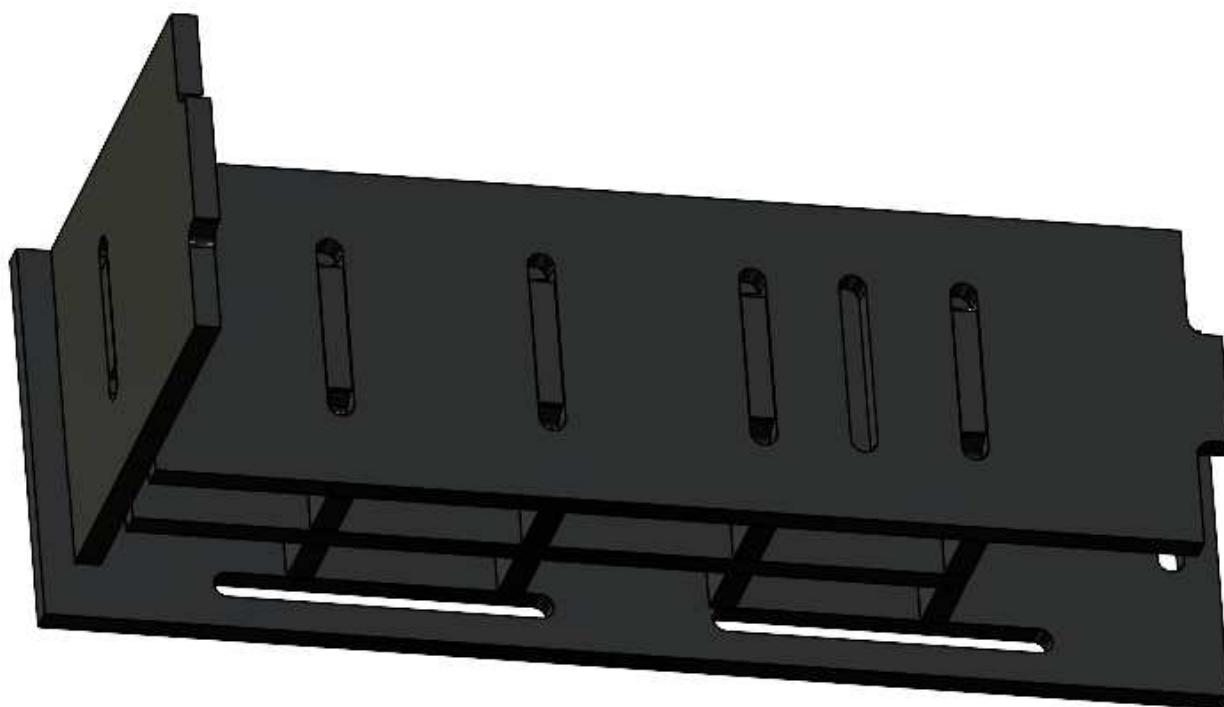

9. Repeat for the right side.



10. Slide the tabs of the bottom of the tray into the horizontal slots in the back. Make sure the socket holes are facing you and on the left side.

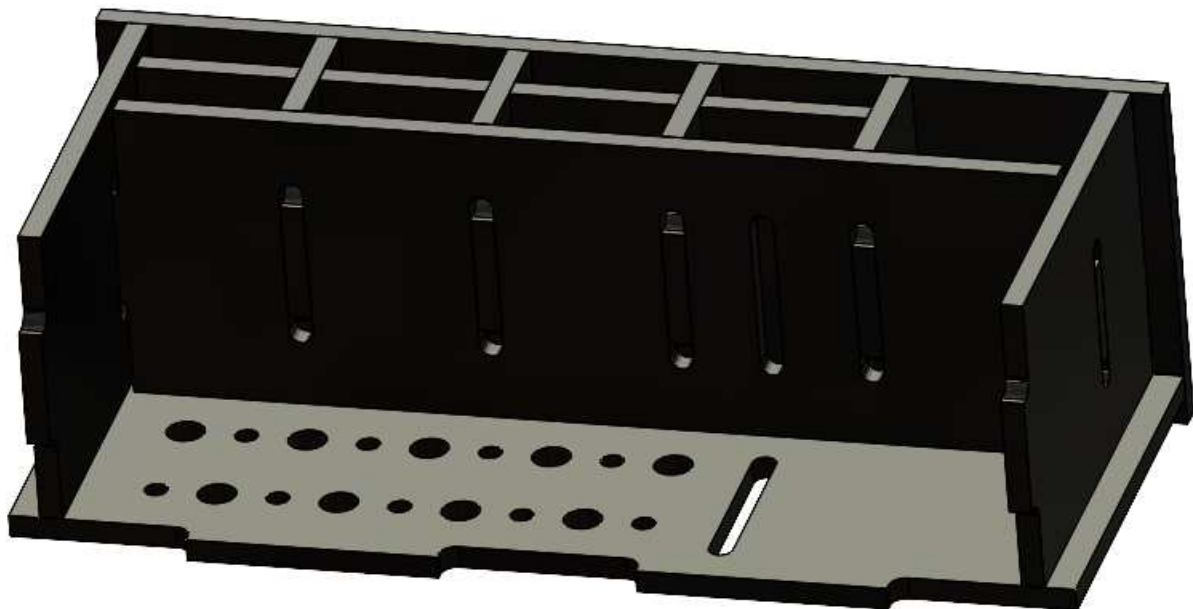

11. Insert the remaining small divider into the slot in the tray bottom. The short side tab goes into the bottom, the long side tab points out towards you.

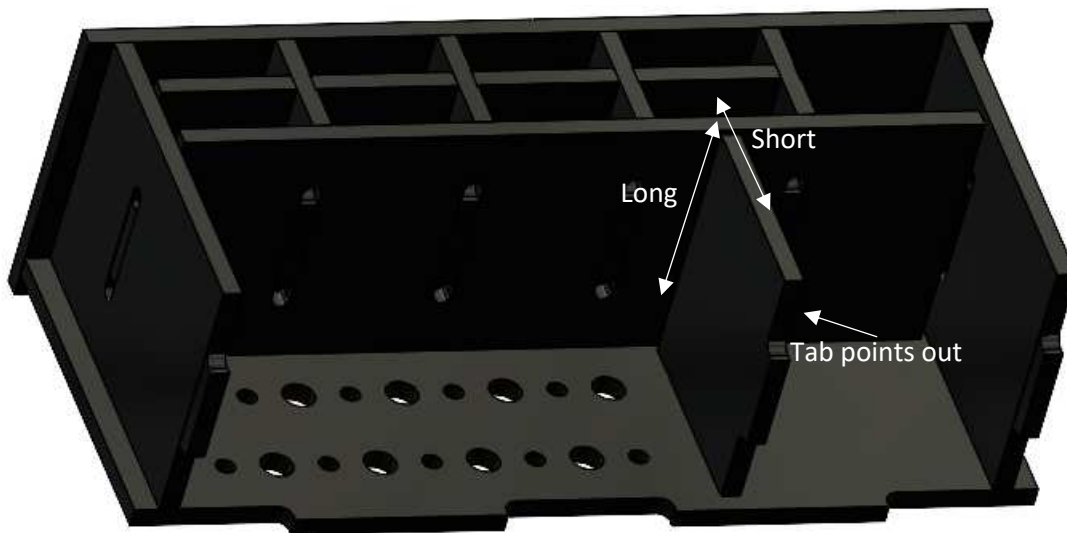
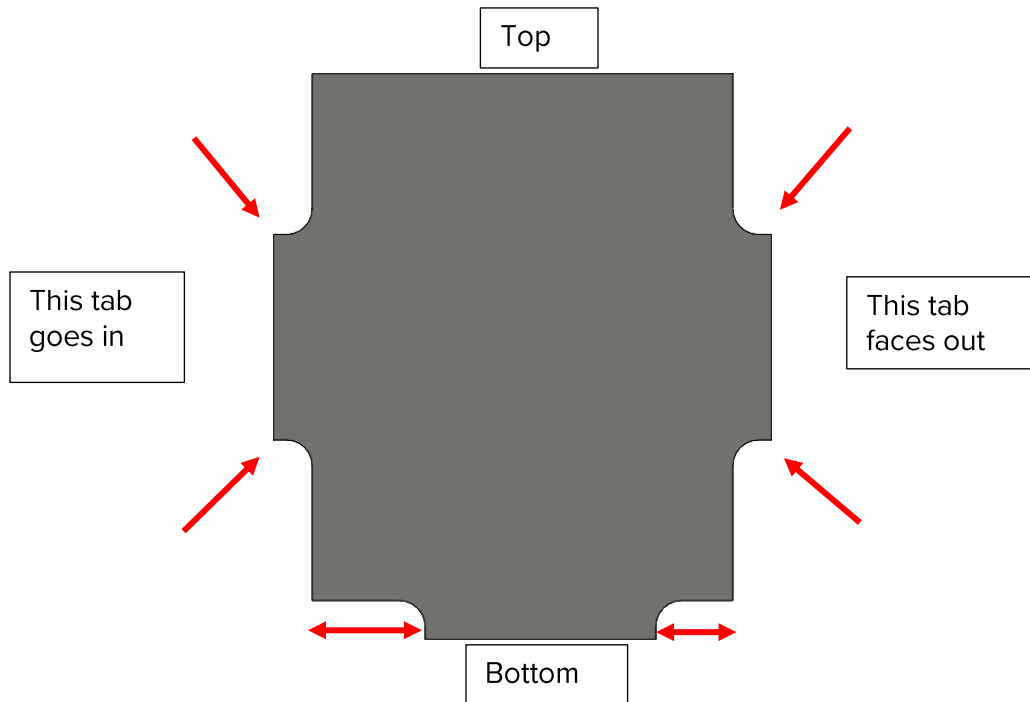

12. Set the front panel down onto all the open tabs. Make sure that the slot in the middle area is on the right to align with the divider from step 11.

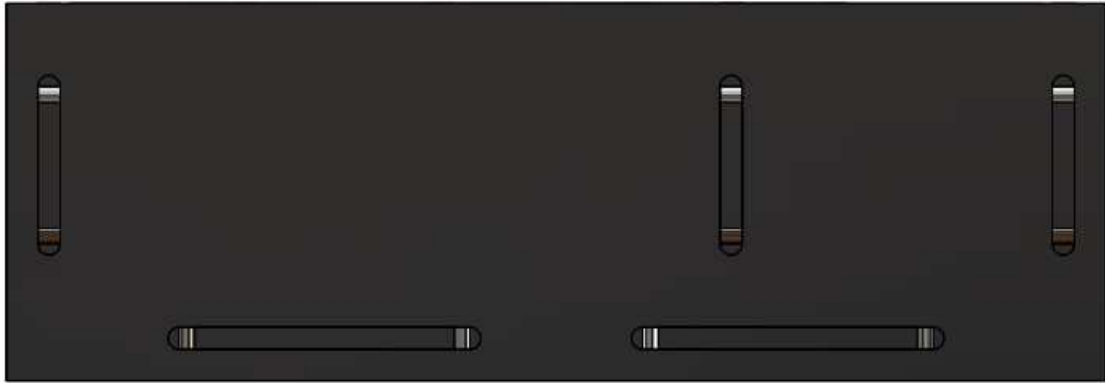

13. The divider is now assembled:

- When you pick it up to put it into your 4509 Tool Tray, make sure to hold it by the front and back sides so the pieces stay together.
- Slightly squeeze inward on the front and back sides and carefully lower it into the tool tray (Fig. 3).
- The completed assembly should appear as shown in Fig. 4.

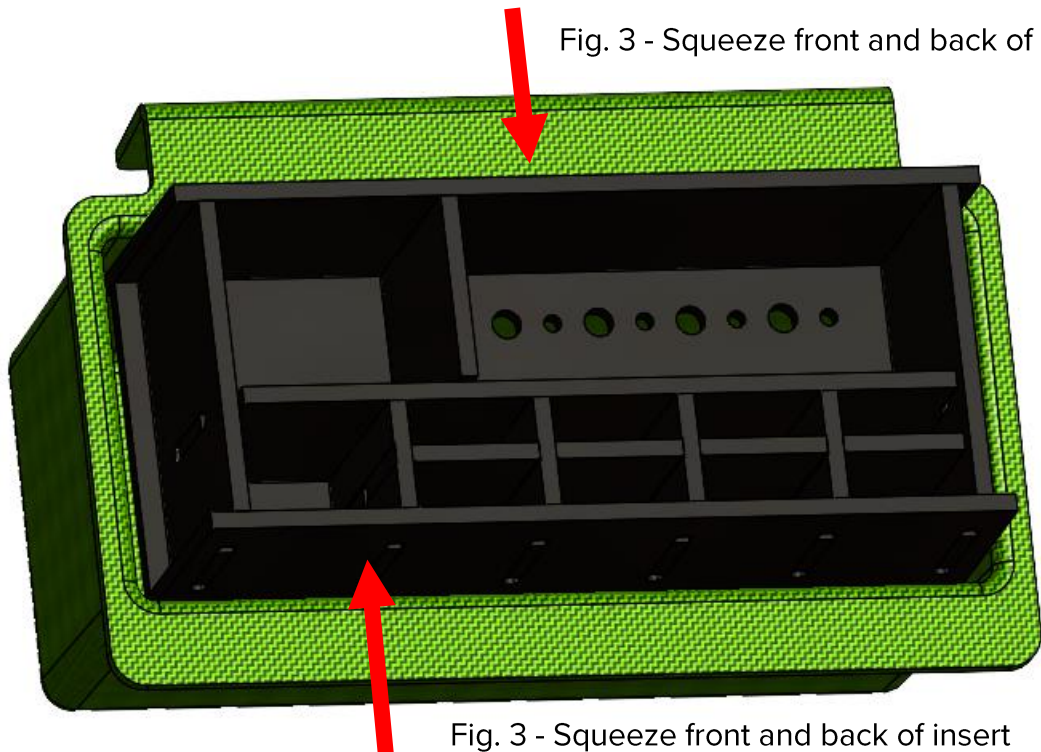

Fig. 3 - Squeeze front and back of insert

Fig. 3 - Squeeze front and back of insert



Fig. 4 – PN 4509 Tool Tray with PN 4509D Divider inserted.

Warnings and Cautions

- Know the job and the regulations governing performance requirements and select the proper equipment.
- Read carefully, understand, and heed these and all other included instructions, warnings, and cautions before using this equipment. Failure to do so could result in your serious injury or death.
- This equipment is intended for use by properly trained professionals only.
- Employer – instruct employees as to proper use, warnings, and cautions before use of this equipment.
- The user must wear approved PPE, including but not limited to, eye protection, gloves, and hard hat.
- Only Buckingham Mfg. Co. or those people authorized in writing by Buckingham Mfg. Co. may make repairs to this product.
- Tool Tray and Divider should not be resold / redistributed or re-used after use by original user.
- Always use caution when working near machinery or moving parts. Straps and loose clothing can hang and become inadvertently entangled.
- Avoid contact of Tool Tray and Divider with sharp edges, abrasive surfaces, high temperature surfaces, welding, or other heat sources, electrical hazards or moving machinery. When not in use, store to prevent exposure to the elements as well as over exposure to sunlight (U.V. degradation).
- Avoid contact of this Tool Tray and Dividers with chemicals that may damage the material. If in doubt, contact Buckingham Mfg. Co.
- Never modify Tool Tray or Dividers.

NOTE: Ensure proper fit / size of product before use. This product **cannot** be returned unless it is in new / unused condition.

STATEMENT of OBSOLESCENCE:

Precise “useful life expectancy” or “shelf life” for this product is not specified, as the degree of use, conditions of use, and the degree of care and storage determines useful life. All users maintain responsibility to select proper equipment for the job, be properly trained in its use, and ensure all personnel support equipment passes inspection before each use. Upon evidence of defects, damage or deterioration, all equipment shall be removed from service immediately and tagged or marked as unusable or destroyed. Additionally, all equipment shall be inspected on a regular basis not to exceed one year by a Competent Person, as defined by OSHA/ANSI, to verify that the equipment is safe for use. In the event of any question or concern regarding the condition of such equipment, users shall remove the equipment from service for further inspection. All users must comply with OSHA/ANSI/ASTM standards prior to and in using such equipment. For more information regarding safe and appropriate use of equipment, please contact Buckingham Manufacturing at 1-800-937-2825.

INTERNATIONAL USERS:

Notwithstanding the above, please know that certain international jurisdictions require manufacturers of equipment to provide customers with a maximum useful lifespan (sometimes referred to as a “Statement of Obsolescence”). To the extent required, Buckingham personal protective equipment manufactured from synthetic fiber materials including but not limited to items such as webbing and/or rope are subject to a maximum useful lifespan of ten (10) years from the date of manufacture. As stated above proper usage, storage, maintenance, and care impacts the useful lifespan of equipment. Extreme circumstances may require that product must be retired after only one use. This statement is made in conformance and compliance with BS EN 365:2004. International users must ensure that product inspections are completed by Competent Persons as defined by international standards including but not limited to British Standard (“BS”). If equipment fails any inspections, it must be immediately withdrawn from service and destroyed. For more information regarding safe and appropriate use of equipment, please contact Buckingham Manufacturing at 1-800-937-2825.

OUR GUARANTEE:

We guarantee the equipment we manufacture to be free from defects in material and workmanship. We will repair any equipment deemed to be defective which is returned to us by the original purchaser. However, this guarantee is void if any product is changed or altered in any way, or if the product is used in a manner other than for which it is intended. This express guarantee supersedes all other expressed or implied guarantees, obligations or liabilities. There are no implied warranties of merchantability or fitness for a particular purpose and as such, all implied warranties are specifically disclaimed.

LIMITATION ON LIABILITY:

In no event will Buckingham or buyer be liable to the other for lost revenues, lost profits or any other indirect, consequential, special or punitive losses or damages, however caused, whether in action for breach of contract, strict liability, tort, or otherwise, even if advised of the possibility of such losses or damages. In no event will Buckingham’s liability exceed the total amount paid by the buyer to Buckingham for the product or equipment giving rise to such claim(s).

Please see other terms and conditions relating to this product at <https://buckinghammfg.com/terms-conditions/>

REGISTRATION:

Before use of the product, ensure to register and confirm the product at www.buckinghammfg.com/register.

BUCKINGHAM MFG.
BINGHAMTON, NY
1-800-937-2825
www.buckinghammfg.com